

CONCRETE AND CLAY ROOF TILE INSTALLATION MANUAL

Published by the TRI Alliance - March 2024 Uniform ES-ER-2015



Beautiful



Versatile



Enduring



TABLE OF CONTENTS

Forward	3
Introduction.....	4
Specifications.....	6
Installation.....	10
Appendix A—Moderate Climate (MC) Diagrams	18
Underlayment Details	19
Batten Details	24
Loading Guide	31
Eave & Fascia Details.....	32
Headwall Details	37
Sidewall Details.....	39
Chimney Details	44
Skylight Details	48
Valley Details.....	51
Boxed-In Soffet Details	55
Hip & Ridge Details.....	56
Parapet & Mansard.....	59
Rake Details.....	60
Roof Vent Details	64
Slope Change Details.....	65
Gutter Details	66
Tile Repair & Replacement	67
Specialty Installations	69
Appendix B—High Wind Applications: Tables, Diagrams and Examples	81
ASCE-7-16 REQUIREMENTS	82
ASCE-7-22 REQUIREMENTS.....	93
Appendix C—Glossary Of Terms.....	104
Conversion Tables	107

Drawing shown depicts the application of all tile profiles. Unless otherwise noted, it would apply to either concrete or clay tiles.

FORWARD

The **Tile Roofing Industry Alliance** (TRI Alliance) is the premier resource for technical information on the proper design and installation of concrete and clay roof tile systems. The TRI Alliance in partnership with its members and outside technical experts have assembled a 2024 version of our regular installation manual that provides a representation of proper installation practices, industry standards, and code requirements. These recommendations have provided successful installations of tile roofs which have endured the test of time while complying with current code requirements.

The TRI Alliance received valuable input from the roofing community as we reviewed the previous 2015 edition of this manual. The culmination of those efforts is the creation of this 2024 Edition of the Installation Manual. As with all previous editions, the TRI Alliance submitted the manual for formal review and issuance of a valid Evaluation Report from an approved evaluation report source. The TRI Alliance has submitted this manual for formal review and issuance of an IAPMO Uniform ES Evaluation Report, ER-2015, to help provide a stronger foundation to the formal practices and recommendations included in this manual.

The TRI Alliance offers additional installation manuals Concrete and Clay Tile Roof Design Criteria Manual for Cold and Snow Regions and 7th Edition FRSA/TRI Concrete and Clay Roof Tile Installation Manual. All of our publications can be ordered through the publication page on our website (www.tilerroofing.org). TRI Alliance's manual certification training programs are designed to train roofers and roofing professionals in code-approved installation methods. Codes are often updated, especially in hurricane-prone and fire-prone regions, and TRI Alliance provides the latest information on rapidly changing standards and upgrades to installation techniques.

TRI Alliance continues to provide the leading edge technology for roof innovations that will provide the highest quality, energy efficient roofing systems available in the market today. Tile roofing systems provide one of the most durable, energy efficient roofing systems found anywhere in the world.

Updates and Bulletins—The Tile Roofing Industry Alliance provides the latest information and updates available directly to you. If you would like to receive notices of any changes, updates, or provide comments on this manual please visit our website www.tilerroofing.org or email us at info@tilerroofing.org and ask to be placed on our email listing for future notices.

LIMITATIONS ON USE AND DISCLAIMER FOR THIS TRI ALLIANCE INSTALLATION MANUAL

These drawings and recommendations are the compilation of the individual experiences of industry members and the Technical Committee of the TRI Alliance. It is intended to be used with the judgment and experience of professional personnel competent to evaluate the significance and limitations of the material contained and who will accept responsibility for its application. The TRI Alliance expressly disclaims any guarantees or warranties, expressed or implied, for anything described or illustrated herein; and assumes no responsibility for error or omissions.



INTRODUCTION

These recommendations are meant for areas that may experience occasional storms, but not regular repetitive freeze thaw cycling. In locations where the January mean temperature is 25 deg. F (-4 deg C) or less or where ice-damming often occurs, the TRI Alliance suggests reference to the Concrete and Clay Tile Roof Design Criteria Manual for Cold and Snow Regions.

While generally considered the minimum standard, proper adherence to these recommendations and attention to detail and workmanship provide a functional roof in most all moderate climate conditions. Local building officials should be consulted for engineering criteria or other special requirements.

The manner in which tile roofs are installed makes them a highly effective water shedding assembly that affords years of service and protection. The effectiveness of a tile roof system as a weather resistant assembly however depends on the proper installation of all the tile roof components, and installing them properly is critical to the performance of the installed system.

Since tile is installed across a wide range of climatic and geographic conditions, there are a variety of details that must be considered in preparing an effective installation. The minimum recommendations shown for moderate regions are effective for a relatively wide range of conditions including occasional storms or snow. While it is not practical to prescribe precise solutions for all conditions, the following has been provided to offer suggestions for various treatments in most climates.

Local building officials should always be consulted to learn of special requirements that may exist. Some of the changes contained will require code approval. This manual provides the minimum design recommendations with optional upgrades for the installation of underlayment, flashings, fastening and related measures to provide a weather resistant roofing assembly for concrete and clay tile.

Designers should be familiar with local climatic conditions and make sure to review the proper design manual. Please see the list of reference publications on page 5 for additional information.

GOVERNING CODE BODIES

Information contained herein is based on values and practices consistent with provisions of the major building codes such as the International Building Code (IBC), International Residential Code (IRC), as promulgated by the International Code Council

(ICC). For evaluation reports for concrete and clay roof tiles that specifically reference this manual, installation shall be in accordance with this manual and the applicable code, unless otherwise noted in the appropriate roof tile evaluation report.

ENVIRONMENTAL STATEMENT

The members of the TRI Alliance are environmentally conscious companies whose policies and practices reflect a commitment to the preservation and welfare of our environment. Our roofing tiles are manufactured in accordance with all prevailing environ-

mental guidelines and are composed of sand, cement, natural clay materials and natural pigments. Because roofing tiles are designed to last long term, they will not add to the tremendous volume of other roofing materials that burden our landfills.

Drawing shown depicts the application of all tile profiles. Unless otherwise noted, it would apply to either concrete or clay tiles.

SAFETY COMPLIANCE

Regular safety training and written policies are suggested to help train and monitor job site safety concerns. Safety & Personal Protective Equipment per Federal & State OSHA Requirements should be used.

Note: Job site safety practices should be in compliance with all Federal and Local OSHA regulations

SAFETY WARNING—TILE DUST

Roofing tiles contain crystalline silica (quartz) and traces of other hazardous substances which are released as dust and can be inhaled when dry-cutting or grinding of this product.

CRYSTALLINE SILICA WARNING

Crystalline silica is a substance known to cause cancer. Other chemicals contained in these products are known to cause cancer, birth defects and other reproductive harm. Please refer to Federal and State OSHA requirements for proper compliance.

REFERENCE PUBLICATIONS

TRIA Industry Installation Guides - Downloadable from our website <https://tileroofing.org/industry/installation-guides/>

TRIA Industry Technical Bulletins - Downloaded from our website <https://tileroofing.org/industry/technical-briefs/>

ASTM Standards for concrete and clay roof tiles. Please refer to the ASTM for the most recent versions of the standards.

ASTM C-1167-22 Standard Specification for Clay Roof Tiles

ASTM C1492-22 Standard Specification for Concrete Roof Tiles

C1568-08 Standard Test Method for Wind Resistance of Concrete and Clay Roof Tiles (Mechanical Uplift Resistance Method)

C1569-03 Standard Test Method for Wind Resistance of Concrete and Clay Roof Tiles (Wind Tunnel Method)

C1570-03 Standard Test Method for Wind Resistance of Concrete and Clay Roof Tiles (Air Permeability Method)

International Building Code (IBC) & International Residential Code (IRC)

CAN/CSA-A220.1-M91 - Installation of Concrete Roof Tiles, by the Canadian Standards Association

Wildfire Urban Interface requirements (WUI)

TERMINOLOGY

Please see Appendix C for a listing of terms associated with roof tile.

TOOLS REQUIRED (Other items may be required per field conditions)

BASIC HAND TOOLS

Tape Measure, Crayon, Chalk, Chalkline, Mortar, Mortar & Mastic Trowel, Caulking Gun, Seam Roller, Snips, Crimper/bender, Knife, Hammer, Prybar, Wood Saw, Brush, Broom, Nail Bag

POWER TOOLS

Drill, 3/16" Masonry Bit, Screw & Nail Gun, Power Cords, Compressor w/ Hose, Tile Saw(s) and Diamond Blades

SPECIALTY TOOLS & EQUIPMENT

Forklift, Conveyor, Tile Cutter, Ladder, Tile Nippers, Layout Tape designed for tile

Drawing shown depicts the application of all tile profiles. Unless otherwise noted, it would apply to either concrete or clay tiles.

MATERIAL CHECKLIST (Other options/upgrades may be allowed per codes)

Decking: Sheathing must be structurally adequate to support the loads involved and of a material recognized in a code evaluation report or as approved by the local building official.

Underlayment: Unless otherwise noted, required underlayment shall be installed per IBC 1507.3.3 that conforms to: ASTM D 226, Type II; ASTM D 2626 or ASTM D 6380, Class M mineral- surfaced roll roofing.

For roof slopes from 2.5:12 up to 4:12 underlayment shall be a minimum of two layers, See page 13.

Battens: Nominal 1" x 2" complying with IBC Chapter 23, section 2302 for nominal size. Counter-batten systems and elevated or raised battens that meet these requirements are also acceptable.

Eave Treatments: Bird Stop/Eave riser.

Valley Flashing: Shall extend each way 12" from center and have a center splash diverter rib 1" high. See Table A on page 7 for more details.

Wall Trays (Pans): Minimum 6" trough. See Table A on page 7 for more details.

Head Wall: "Rigid metal or flexible flashing, 3" minimum lap over tile." See Table A on page 7 for more details.

Pipe Flashing: Deck & Tile flashing is required. Medium and high profile tile flashing to be malleable flashings. See Table A on page 7 for more details.

Counter Flashing: Z bar recommended or surface mount reglet (pin) Flashing for w. See Table A, page 7 for more details.

Fasteners: See page 9 and Tables 1A, 1B & 1C for requirements.

Ventilation: Per local building code requirements.

ROOF TILE CLASSIFICATIONS

Roof tiles are typically of the following types: Low/Flat, Medium, and High Profile

Low Profile Tile – Tiles, such as flat tile that have a top surface rise of 1/2" or less.

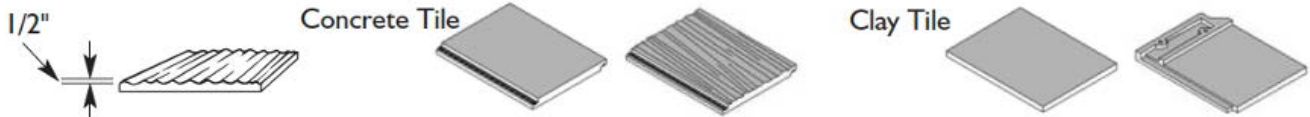

Medium Profile Tile – Tiles having a rise to width ratio equal to or less than 1:5



High Profile Tile – Tiles having a rise to width ratio greater than 1:5 (measured in installed condition)

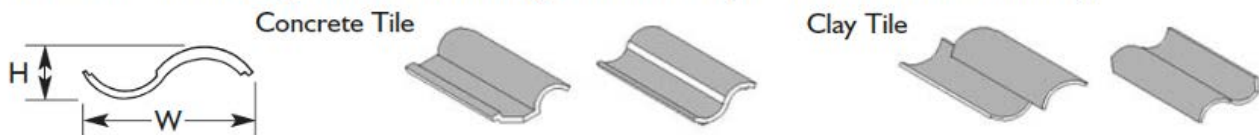

Accessory Tile – Shall include those tile such as ridge, rake, hip, valley and starter tile used in conjunction with those tile listed above.

Drawing shown depicts the application of all tile profiles. Unless otherwise noted, it would apply to either concrete or clay tiles.

TABLE A: REFERENCE TABLE FOR DRAWING DETAILS

TYPE	MINIMUM SPECIFICATION	DETAILS
VALLEY FLASHING	NO. 26 GAUGE GALVANIZED SHEET NOT LESS THAN 0.019" ASTM A653 G90	MC-12B, MC-17, MC-17A, MC-17B
PAN FLASHING CHANNEL FLASHING WALL TRAYS FLASHING		MC-12, MC-12A, MC-12B, MC-13, MC-13A
HEADWALL FLASHING ROOF TO WALL FLASHING APRON FLASHING		MC-11, MC-11A
ROOF TO WALL FLASHING Z BAR FLASHING		MC-11, MC-11A
DRIP EDGE FLASHING EAVE FLASHING		MC-10, MC-10A, MC-10B, MC-10C, MC-10D
RAKE FLASHING		MC-12B, MC-19, MC-19A
CHIMNEY FLASHING SKYLIGHT FLASHING SADDLE FLASHING		MC-14, MC-14A, MC-15, MC-15A, MC-16A, MC-16B
PIPE FLASHING DECK FLASHING		MC-02, MC-21
ROOF VENTS ATTIC VENTS		MC-21
MALLEABLE FLASHING		SOFT LEAD NOT LESS THAN 2.5 LBS / SQ.FT DEAD SOFT ALUMINUM NOT LESS THAN 0.019" SOFT COPPER NOT LESS THAN 16 OZ/SQ.FT...or Decay corrosion resistant water proof materials designed for exposure to elements.

Note: The flashing specifications stated in Table A are considered minimum requirements. For other materials, see IBC Tables 1507.4.3(1) and 1507.4.3(2) or IRC Tables R905.10.3(1) and R907.10.3(2), as applicable.

TABLE B: ACCESSORIES

TYPE	SPECIFICATION	DETAILS
BIRD-STOP	PER MANUFACTURER	MC-10A, MC-10B, MC-10C, MC-23, MC-25
EAVE RISER		MC-10, MC-10B
WEATHER BLOCKING		MC-18, MC-18A, MC-18C

Drawing shown depicts the application of all tile profiles. Unless otherwise noted, it would apply to either concrete or clay tiles.

TILE SPECIFICATIONS/RECOMMENDATIONS

Freeze Thaw: Different climatic conditions will result in the need for different roofing materials that will allow the success of the roofing system over the long-term. Resistance to freeze/thaw is very important in weathering situations where the roofing material is expected to withstand repetitive freezing and thawing cycles. Both Concrete and Clay Tile used in these conditions must have passed the requirements of ASTM C1492 (Concrete) ASTM C1167 (Clay) for freeze thaw regions.

Strength: A Concrete (ASTM C1492) or Clay tile's (ASTM C1167) transverse strength will meet or exceed requirements of the specified codes.

Thickness: Roof tile typically ranges in thickness from 3/8" to 1/2", depending upon composition, type and style.

Quantities of Tile Per Square: The size of the tile and the exposure of each course of tile determines the number of tiles needed to cover one square (100 sq. ft.) of roof area. When the tiles are installed at the manufacturer's maximum exposure, the number of tiles needed to cover one square of roof area may range from 75 to over 400 pieces.

Tile Weight: The size of the tile and the exposure of each course will determine the installed weight of the roof tiles. In general, the amount of tiles to cover one square (100 sq ft.) set at the standard 3 inch head lap, will depend on the thickness, length, width, shape and aggregate materials used in the manufacturing process of the tile. Please consult with the tile manufacturer when determining the weight of the specific tile that will be used. As with any roofing material the designer should always consider the weight of the underlayment, fastening system, roof accessories and special hip/ridge treatments.

MATERIALS AND MANUFACTURE

Concrete Tile: Cementitious materials such as portland cement, blended hydraulic cements and fly ash, sand, raw or calcined natural pozzolans and aggregates shall conform to the following Concrete Tile ASTM C1492 Specifications.

Clay Tile: Tiles are manufactured from clay, shale, or other similar naturally occurring earthly substances and subjected to heat treatment at elevated temperatures (firing). The heat treatment must develop a fired bond between the particulate constituents to provide the required strength and durability.

Clay Tile ASTM C1167 Specifications: Additional Standards for Concrete & Clay Tile may be referenced in the following additional standards:

IBC/IRC, ASCE 7-16, CC-ES AC 152, ICC-ES AC180,
CAN/CSA-A220.1-M91, State and Local Building Codes

Adhesive: Bonding materials designed to adhere tiles to other tiles or substrate such as mortar, synthetic mortar, mastics, silicones, polymers, Tri-polymers, or other materials approved by the local building official. Contact the adhesive manufacturer for additional information. Refer to current evaluation reports of roof tile adhesives for installation requirements and conditions of use.

Batten: A sawed strip of wood installed horizontally and parallel to the eave line which is mechanically attached to the roof deck or rafters to engage the anchor lugs of the tiles, when applicable, to prevent slippage of the roof tile. Battens of nominal 1"x 2"

lumber complying with IBC Chapter 23, section 2302 may be dimensionally increased in size to accommodate structural loads for snow or unsupported spans over counter battens or rafters. Battens may also be corrosion resistant metal or other man-made material that meets the approval of the local building official. In dry/low humidity climates decay resistant battens are not required. See Tables 1A,1B & 1C on pages 14 and 15.

Battens installed over counter battens or those which span over rafters commonly are of soft wood, spruce, pine, or fir type species but may be of any type of lumber, metal or man-made materials that meet the approval of the local building official. See table 2 on page 16.

Counter Battens: Counter-batten systems and elevated or raised battens that meet these requirements are also acceptable. Additional set of battens installed vertically and parallel to the roof slope and mechanically attached to the roof deck under the batten. Counter battens are commonly 1/4 inch lath but may be dimensionally increased in size to provide a greater flow of air or moisture beneath the horizontal battens. Counter battens do not need to be of decay resistant lumber as they do not impede moisture flow. Counter battens may also be of corrosion resistant metal or other man-made materials that meet the approval of the local building official. See table 2 on page 16.

Note: *If counter battens are installed under the underlayment, caution must be used to prevent damage to underlayment or reinforced underlayment shall be used.*

Drawing shown depicts the application of all tile profiles. Unless otherwise noted, it would apply to either concrete or clay tiles.

Note: Care should be taken in selecting the proper batten design. Excessive deflection of the batten may lead to tile breakage. See table 2 on page 16.

Caulking and Sealant: Caulking and sealants shall be suitable for exterior use and be resistant to weathering. The caulking and sealants shall be compatible with and adhere to the materials to which they are applied.

Nails and Fastening Devices: Nails and fastening devices must be corrosion resistant meeting ASTM A641 Class 1 or other approved corrosion resistance. They must also be No. 11 gauge diameter and of sufficient length to properly penetrate 3/4" into or through the thickness of the deck or batten, whichever is less. The head of the nail used for tile fastening shall not be less than 5/16" (.3125") and complying with ASTM F 1667 for dimensional tolerances (+0%, -10%).

Nail Length:

Nailing of Batten—Nails for fastening battens shall have sufficient length to penetrate at least 3/4" into the roof frame or sheathing.

Nailing Tile to Batten and Direct Deck Systems—Nails for fastening roof tiles shall penetrate at least 3/4" into the batten or through the thickness of the deck, whichever is less. Once the batten is installed it becomes part of the deck for fastening purposes.

Nailing Tile to Battens on Counter Batten—Nails for fastening roof tiles shall penetrate at least 3/4."

Nailing Accessories—Where nail(s) are required for fastening accessories, such nails shall have sufficient length to penetrate at least 3/4" into the supporting member.

Screws: Corrosion resistant meeting code approval equal of sufficient length to properly penetrate 3/4" into or through the thickness of the deck or batten, whichever is less. Screw diameter and head size should be selected to meet good roofing practices and the screw manufacturer's recommendations. See above section on nail length for additional requirements.

Staples for Battens: No 16 gauge by 7/16 inch-crown by minimum 1/2 inch long corrosion-resistant staples.

Flashing: Flashing shall be installed at wall and roof intersections, wherever there is a change in roof slope or direction and around roof openings. Where flashing is of metal, it shall be a minimum of;

0.019" Galvanized (G90)

0.019" Aluminum

16 Oz Copper

2.5 lb Soft Lead

Underlayment Materials: Unless otherwise noted, required underlayment shall be installed per IBC 1507.3.3 that conforms to: ASTM D 226, Type II; ASTM D 2626 or ASTM D 6380, Class M mineral-surfaced roll roofing. For roof slopes from 2½:12 up to 4:12 underlayment shall be a minimum of two layers. See page 13.

Synthetics Underlayment material: Where synthetics are installed, please consult with the underlayment manufacturer to determine fit for use under concrete and clay tiles.

GENERAL INFORMATION—The TRI Alliance has created technical bulletins on many of these topics and more that can be found at www.tilerooting.org

Algae/Organic Growth: In certain climatic regions of the country, the development of algae and/or organic growth can occur on any building material. The growth of moss and organic growth form on the dirt and moisture on the surface of the tile. Unlike other roofing materials, these items can easily be treated and do not deteriorate the roofing tile.

In most cases the use of a high pressure cleaner will remove the presence of the moss that traditionally grows in the dirt/pine needles or other debris that accumulates on the edge of the tile. Note that you may wish to contact a professional to clean your roof, since steep slope roofs can be dangerous to walk on when wet. Caution of not spraying upslope or into side walls.

Color Shading: Slight variations in sand, cement, and color oxides (natural products) can cause minimal color shading. This slight variance is not detectable through standard quality control practices. In order to minimize color patterning, stair stepping, or hot-spots, tiles should be selected and spread over the entire roof plane when loading the tiles onto the roof.

Broken Tile Replacement: To remove a broken tile, cut any fasteners, remove the broken pieces of tiles, remove the fasteners and repair the underlayment. If the tiles were installed on battens and the tile has batten lugs, a new tile may be inserted to hang on the batten. If no battens were used, a 12" x 6" by 1/2" plywood piece is nailed to the deck to act as a batten.

As an alternative, replacement tiles may be inserted using roofers mastic, hooks, wires or approved adhesives to bond at the head lap area. See page 67 (Tile Repair).

Efflorescence: Efflorescence is a temporary surface discoloration common to all concrete based roofing tile. It is in no way detrimental to the overall quality, structural integrity, or functionality of the tile. Efflorescence is caused by the chemical nature of the cement. Manufactured cement contains free lime, and when water is added, a series of chemical reactions take place releasing calcium hydroxide which can form a white chalky crystalline salt deposit on the tile surface when reacting with carbon dioxide. This reaction can appear as an overall "bloom" (overall softening of color) or in more concentrated patches. See our technical bulletin at <https://tileroofing.org/industry/technical-briefs/>.

It is difficult to predict how long the effects of efflorescence will last. It depends on the type and amount of deposit as well as the local weather conditions. The action of carbon dioxide and rain water will gradually, in most cases, remove the deposit, leaving the original color of the concrete roof tile intact without further efflorescence.

Walkability: The inert nature of tile, its characteristics of strength over age, and its durability will contribute to a long term life expectancy. With a good installation and reasonable precautions against severe roof traffic, a tiled roof system will require very low maintenance.

Walking on roofing tile should be avoided and only done with extreme caution. Place antennas and roof mounted equipment where a minimum of roof traffic will be necessary for servicing and maintenance. If necessary to walk on the tile surfaces pressure should only be applied on the head-lap of the tiles (lower 3-4 inches). This distributes the load near the bearing points of the tile. When painting or repairing adjoining walls or appurtenances, tiles can be removed for the adjoining work and reset after the completed work requiring heavy foot traffic. The tile surface can also be safely covered with secured plywood or roof pads available from many roof tile manufacturers to distribute traffic loads and prevent dirt, building materials, and paint/stain from damaging or discoloring the tile. If necessary to walk on the tile surfaces pressure should only be applied on the head-lap of the tiles (lower 3-4 inches). This distributes the load near the bearing points of the tile. When painting or repairing adjoining walls or appurtenances, safely cover the tile surface with secured plywood to distribute traffic loads and prevent dirt, building materials, and paint/stain from damaging or discoloring the tile.

Weather Effects On Tile: After constant exposure to nature's elements, some tiles can be expected to lighten to some degree from the original color or lose some surface texture. This is due primarily to the effects of oxidation on the surface of the tile. This will not effect the structural integrity or water shedding ability of the tile.

Vermin Screening: Metal, honeycomb plastic, foam fillers, mortar or equivalent should be considered to seal larger openings into the roof system. This will help minimize the access of birds and vermin infiltration.

Drawing shown depicts the application of all tile profiles. Unless otherwise noted, it would apply to either concrete or clay tiles.

NEW CONSTRUCTION—Please consult with the individual manufacturer and local building officials for additional information

In locations where the January mean temperature is 25 deg. F (-4 deg C) or less or where ice damming often occurs, the TRI Alliance suggests reference to the Concrete and Clay Tile Roof Design Criteria Manual for Cold and Snow Regions.

Sheathing: Sheathing must be structurally adequate to support the loads involved and of a material recognized in a code evaluation report or as approved by the local building official.

Underlayment: Unless otherwise noted, required underlayment shall be installed per IBC 1507.3.3 that conforms to: ASTM D 226, Type II; ASTM D 2626 or ASTM D 6380, Class M mineral-surfaced roll roofing.

On roof slopes below 3:12 an approved multi-ply membrane roof such as a built-up roof system, applied in accordance with page 13, or a single-ply roof membrane assembly, or other underlayment systems approved by the local building official, is first installed. Tile installed at less than 3:12 shall be considered decorative.

Where roof slopes fall between 3:12 and under 4:12, underlayment shall be as described in the previous paragraph, underlayments meeting ASTM D1970 (such as EPDM, Ice and Water Shield), or two layers of ASTM D226 Type II (No 30 felt) (ASTM D4869 Type IV), installed shingle fashion, or single ply roof membrane assembly installed per code, or other approved underlayments.

Roof Layout: To achieve the optimum performance and appearance, the roof area between the eave and ridge should be divided into equal tile courses when possible. A minimum 3-inch overlap must be maintained for all tile, tile courses unless precluded by tile design. The actual layout of the roof courses will be determined by the length of the roof courses the specific tile being installed. Profiled tiles can be installed either straight or staggered bond.

Batten Installation: Tiles with projecting anchor lugs installed on battens below 3:12 slopes have one of the following batten systems or other methods as approved by the local building officials.

Nominal 1 inch by 2 inch, or greater, wood batten strips installed over a counter batten system are required for roof slopes below 3:12 in order to minimize penetrations of the waterproofing membrane by fasteners. Nominal 1 inch by 2 inch, or greater, wood battens are required where slopes exceed 7:12, to provide positive tile anchoring. Battens are nailed to the deck with 8D corrosion resistant box nails 24 inches on center, or No 16 gauge by 7/16 inch-crown by 1½ inch long corrosion-resistant staples 12-inch centers, allowing a 1/2" separation at the batten ends. Tile installed on roof slopes of less than 3:12 are considered

decorative only and must be applied on counter battens over an approved membrane roof covering, subject to local building official approval.

Battens installed on roof slopes of 4:12 to 24:12 shall be fastened to the deck at no greater than 24 inches on center, and shall have provisions for drainage by providing ½-inch separation at the batten ends every 4 feet, or by shimming with a minimum 1/4" material of wood lath strips, 2-inch shims, cut from multiple layers of material, placed between the battens and deck to provide drainage beneath the battens or other methods approved by the local building official. Tile installed without projecting anchor lugs may be installed as provided above as an optional method of installation.

Counter Batten System – Counter battens 1/4" and larger in height will be installed vertically on the roof to provide the space between the battens, to which the tiles are attached, and the roof deck, thus facilitating air flow capability and moisture drainage. Taking the anticipated roof loading into account, design consideration should be given to the size and quality of the wooden battens or sheathing boards used to support the roof tile covering.

If the battens are not strong enough to support the anticipated loading, including the roof tile and snow and/or ice, the battens could deflect between the support points causing roof tile breakage and/or other roof damage. Knots and knot holes weaken the batten. See Table 2 on page 12. If a counter batten system is to be installed under the underlayment, caution must be used to prevent damage to the underlayment or a reinforced underlayment will be used.

Re-Roof: Prior to installation, all foreign matter will be cleaned from all interlocking areas. Cracked or broken tile must be removed from the roof. Damaged, rusted, improper flashing will be replaced when re-roofing.

For re-roof, clay and concrete roofing tiles, recognized as a Class A roof assembly passing testing according to ASTM E 108, UL 790 or recognized in accordance with IRC section R902.1, may be allowed to be installed over existing asphalt shingles, plywood or OSB. In lieu of such underlayments being provided, the building official has the discretion to determine if the existing roof covering provides the required underlayment protection. Check with local building official for any additional requirements.

Drawing shown depicts the application of all tile profiles. Unless otherwise noted, it would apply to either concrete or clay tiles.



VENTILATION GUIDELINES

The need for proper attic ventilation, in accordance with the IBC and IRC, is required by most building code authorities. These codes recognize that the proper ventilation is a necessary component of any successful steep slope roof system.

Generally building codes require that a minimum net free

ventilating area for attic vents be a 1:150 ratio of the attic space being ventilated. The codes generally allow for the reduction of the ratio from 1:150 to 1:300 if the attic vents are a balanced system on a roof and/or a vapor retarder is installed on a ceiling assembly's warm side. Check with local building official for regional requirements for ventilation.

Drawing shown depicts the application of all tile profiles. Unless otherwise noted, it would apply to either concrete or clay tiles.

TILE INSTALLATION REQUIREMENTS (Replaces Table 1A and 1B in previous manuals)

Please see International Building Code (IBC), International Residential Code (IRC) and local building codes for addition requirements.

Underlayment: Unless otherwise noted, required underlayment shall be installed per IBC 1507.3.3 that conforms to: ASTM D 226, Type II; ASTM D 2626 or ASTM D 6380, Class M mineral-surfaced roll roofing.

Low-slope roofs: For roof slopes from 2 1/2 : 12 up to 3:12, see page 11.

High-slope roofs:

1) For roof slopes of 4:12 or greater, underlayment shall be a minimum of one layer of underlayment felt applied shingle fashion, parallel to, and starting from the eaves and lapped 2 inches, fastened only as necessary to hold in place.

2) Starting at the eave, a 19-inch strip of underlayment shall be applied parallel with the eave and fastened sufficiently in place

3) Starting at the eave, 36-inch-wide strips of underlayment felt shall be applied overlapping successive sheets 19 inches and fastened sufficiently in place.

High wind attachment:

1) High wind as defined to be wind design velocities, V_{asd} , greater than 110 mph as determined in accordance with IBC Section 1609.3.1 shall be applied with corrosion-resistant fasteners in accordance with the manufacturer's installation instructions. Fasteners are to be applied along the overlap not more than 36 inches on center.

2) High wind [V_{asd} , equals or exceeds 120 mph] shall be attached in a grid pattern of 12 inches between side laps with a 6-inch spacing at the side laps. Underlayment shall be applied in accordance with Sections 1507.3.3.1 and 1507.3.3.2 except all laps shall be a minimum of 4 inches.

Underlayment shall be attached using metal or plastic cap nails with a head diameter of not less than 1 inch with a thickness of at least 32-gage (0.0134 inch) sheet metal. The cap nail shank shall be a minimum of 12 gauge (0.105 inch) with a length to penetrate through the roof sheathing or a minimum of 3/4 inch into the roof sheathing.

Exception: As an alternative, adhered underlayment complying with ASTM D 1970 shall be permitted.

Tile Fastener: Tile fasteners shall be corrosion resistant and not less than 11-gage, 5/16-inch head, and of sufficient length to penetrate the deck a minimum of 3/4 inch or through the thickness of the deck, whichever is less. Attaching wire for clay or concrete tile shall not be smaller than 0.083 inch. Perimeter fastening areas include three tile courses but not less than 36 inches from either side of hips or ridges and edges of eaves and gable rakes.

Drawing shown depicts the application of all tile profiles. Unless otherwise noted, it would apply to either concrete or clay tiles.

**TABLE 1A—ALL TILES: General - Concrete or Clay Roof Tile Attachment A,B,C**

MAXIMUM NOMINAL DESIGN Wind Speed V_{asd} (mph) ^F	MEAN ROOF HEIGHT (Feet)	ROOF SLOPE BELOW 3:12	ROOF SLOPE 3:12 AND OVER
85	0-60	ONE FASTENER PER TILE. FLAT TILE WITHOUT VERTICAL LAPS, TWO FASTENERS PER TILE.	TWO FASTENERS PER TILE. ONLY ONE FASTENER PER TILE ON ROOF SLOPES OF 7:12 AND LESS FOR TILES WITH INSTALLED WEIGHTS EXCEEDING 7.5 LBS/SQ FT. HAVING A WIDTH NO GREATER THAN 16 INCHES.
100	0-40		
100	>40 -60	THE HEAD OF ALL TILES SHALL BE NAILED. THE NOSE OF ALL EAVE TILES SHALL BE FASTENED WITH APPROVED CLIPS. ALL RAKE TILES SHALL BE NAILED WITH TWO NAILS. THE NOSE OF ALL RIDGE, HIP AND RAKE TILES SHALL BE SET IN A BEAD OF ROOFERS MASTIC.	
110	0-60	THE FASTENING SYSTEM SHALL RESIST THE WIND FORCES IN IBC SECTION 1609.5.3	
120	0-60	THE FASTENING SYSTEM SHALL RESIST THE WIND FORCES IN IBC SECTION 1609.5.3	
130	0-60	THE FASTENING SYSTEM SHALL RESIST THE WIND FORCES IN IBC SECTION 1609.5.3	
ALL	>60	THE FASTENING SYSTEM SHALL RESIST THE WIND FORCES IN IBC SECTION 1609.5.3	

**TABLE 1B—ANCHOR LUGS, BATTENS:
INTERLOCKING CONCRETE OR CLAY TILE WITH PROJECTING ANCHOR LUGS D,E
(Installations on spaced/solid sheathing with battens or spaced sheathing)**

MAXIMUM NOMINAL DESIGN Wind Speed V_{asd} (mph) ^F	MEAN ROOF HEIGHT (Feet)	ROOF SLOPE 5:12 AND BELOW	ROOF SLOPE ABOVE 5:12 TO 12:12	ROOF SLOPE 12:12 AND OVER
85	0-60	FASTENERS NOT REQUIRED. TILES WITH INSTALLED WEIGHT LESS THAN 9 LBS/SQ.FT. REQUIRE A MINIMUM OF ONE FASTENER PER TILE.	ONE FASTENER PER TILE EVERY OTHER ROW. ALL PERIMETER TILES REQUIRE ONE FASTENER. TILES WITH INSTALLED WEIGHT LESS THAN 9 LBS/SQ.FT. REQUIRE A MINIMUM OF ONE FASTENER PER TILE.	ONE FASTENER REQUIRED FOR EVERY TILE. TILES WITH INSTALLED WEIGHT LESS THAN 9 LBS/SQ.FT. REQUIRE A MINIMUM OF ONE FASTENER PER TILE.
100	0-40			
100	>40 -60	THE HEAD OF ALL TILES SHALL BE NAILED. THE NOSE OF ALL EAVE TILES SHALL BE FASTENED WITH APPROVED CLIPS. ALL RAKE TILES SHALL BE NAILED WITH TWO NAILS. THE NOSE OF ALL RIDGE, HIP AND RAKE TILES SHALL BE SET IN A BEAD OF ROOFERS MASTIC.		
110	0-60	THE FASTENING SYSTEM SHALL RESIST THE WIND FORCES IN IBC SECTION 1609.5.3		
120	0-60	THE FASTENING SYSTEM SHALL RESIST THE WIND FORCES IN IBC SECTION 1609.5.3		
130	0-60	THE FASTENING SYSTEM SHALL RESIST THE WIND FORCES IN IBC SECTION 1609.5.3		
ALL	>60	THE FASTENING SYSTEM SHALL RESIST THE WIND FORCES IN IBC SECTION 1609.5.3		

Drawing shown depicts the application of all tile profiles. Unless otherwise noted, it would apply to either concrete or clay tiles.

**TABLE 1C—ANCHOR LUGS, DIRECT DECK:
INTERLOCKING CONCRETE OR CLAY TILE WITH PROJECTING ANCHOR LUGS
(Installations on solid sheathing without battens)**

MAXIMUM NOMINAL DESIGN Wind Speed V_{asd} (mph) ^F	MEAN ROOF HEIGHT (FEET)	ALL ROOF SLOPES
85	0-60	One fastener per tile.
100	0-40	
100	>40-60	The head of all tiles shall be nailed. The nose of all eave tiles shall be fastened with approved clips. All rake tiles shall be nailed with two nails. The nose of all ridge, hip and rake tiles shall be set in a bead of roofers mastic.
110	0-60	The fastening system shall resist the Wind Forces in IBC Section 1609.5.3
120	0-60	The fastening system shall resist the Wind Forces in IBC Section 1609.5.3
130	0-60	The fastening system shall resist the Wind Forces in IBC Section 1609.5.3
All	>60	The fastening system shall resist the Wind Forces in IBC Section 1609.5.3

Notes:

1. Minimum fastener size. Corrosion-resistant nails not less than No. 11 Gage with 5/16 inch head. Fasteners shall be long enough to penetrate into the sheathing 3/4 inch or through the thickness of the sheathing, whichever is less. Attaching wire for clay and concrete tile shall not be smaller than 0.083 inch.
2. Snow areas. Minimum of two fasteners per tile are required or battens and a fastener.
3. Roof slopes greater than 24:12. The nose of all tiles shall be securely fastened.
4. Horizontal battens. Battens shall be not less than 1 inch by 2 inch nominal. Provisions shall be made for drainage by a minimum of 1/8 inch riser at each nail or by 4-foot -long battens with at least a 1/2-inch separation between battens. Horizontal battens are required for slopes over 7:12.
5. Perimeter fastening includes three courses but not less than 36 inches from either side of hips or ridges and edges of eaves and gable.
6. V_{asd} (Average Strength Design) shall be determined in accordance with IBC section 1609.3.1

Drawing shown depicts the application of all tile profiles. Unless otherwise noted, it would apply to either concrete or clay tiles.

TABLE 2—WOOD BATTEN ALLOWABLE LOADS

Batten and counter batten allowable loads according to species and nominal dimensions

(Allowable load includes the total combined live and dead load)

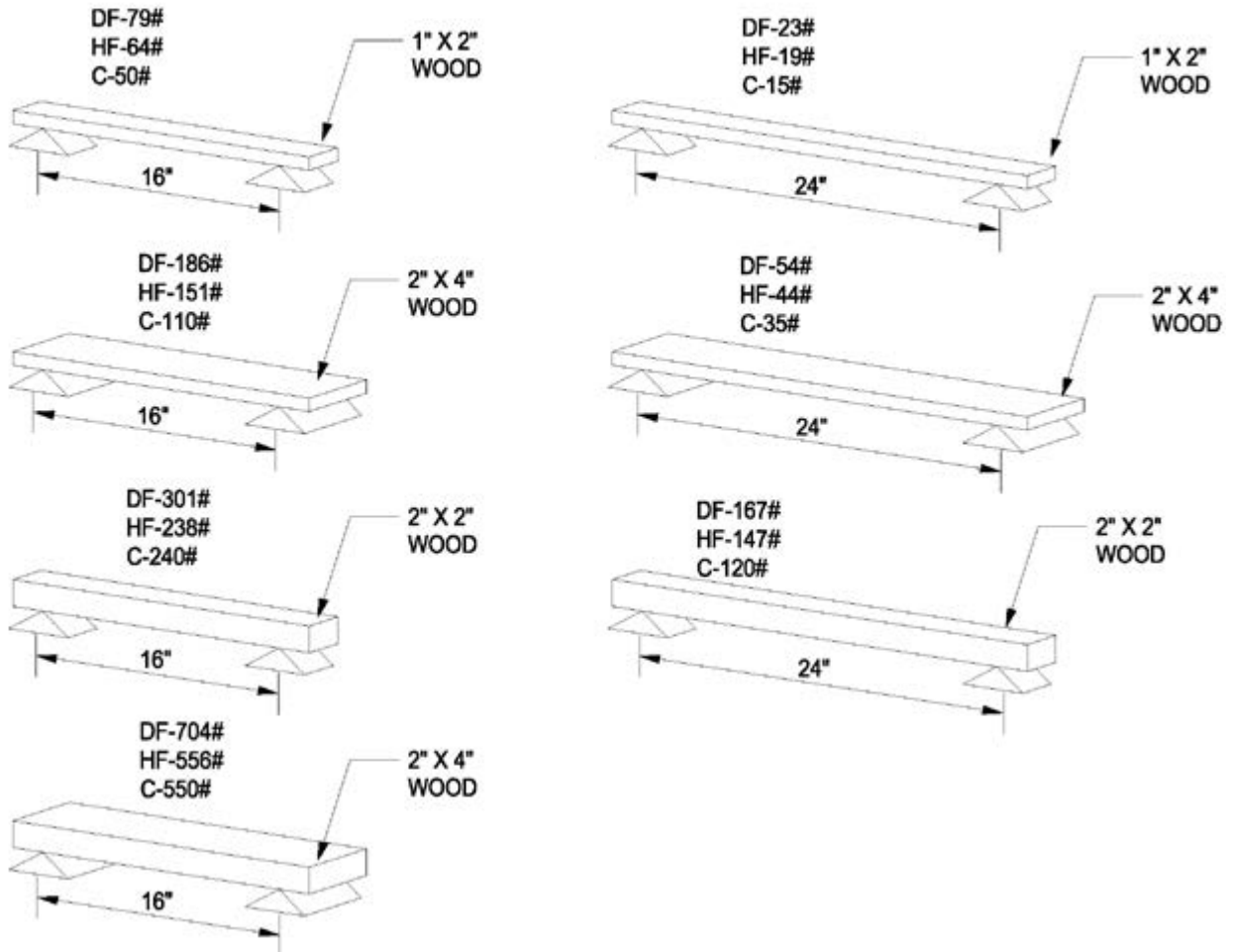

NOTES: HF = Hem Fir, DF = Douglas Fir, C = Western Cedar (spaced at 10" maximum on center) (above values were based upon stress rated boards)

The above table was created as part of the TRI Cold Weather Installation Guide for additional recommendations in cold weather applications, available at www.tilerroofing.org

Drawing shown depicts the application of all tile profiles. Unless otherwise noted, it would apply to either concrete or clay tiles.

TABLE 3—GUIDELINES FOR BATTENS & COUNTER BATTENS

ROOF SLOPE	STANDARD REQUIREMENTS	OPTIONAL UPGRADE(S)
2 1/2 / 12 (21%) TO LESS THAN 3/12 (25%)	Counter Batten System Refer to Counter Batten Systems (Page 6) & MC-05 / MC-06A. Counter-batten systems and elevated or raised battens that meet these requirements are also acceptable.	Alternates: Corrosion resistant metal, or other man-made MC-06A material that meets the allowable loads (see Table 2), in a valid and approved evaluation report ,and/or approval of the local building official.
3/12 (25%) TO 7/12 (58.3%)	Not Required See below for special climatic conditions	Nominal* 1" x 2" x 4' or less (min 1/2" separation between battens)
		Nominal* 1" x 2" x greater than 4' (Provision for drainage beneath batten with min 1/4" thick decay-resistant riser at each fastener)
		Counter Batten Refer to Counter Batten Systems (Page 11) & MC-05 / MC-06A
		Alternates Corrosion resistant metal, or other man made material that meets the approval of the local building official and/or a valid and recognized batten system.
GREATER THAN 7/12 (58.3%)	Nominal* 1" x 2" x 4' (min 1/2" separation between battens)	Counter Batten Refer to Counter Batten Systems (Page 6) & MC-05 / MC-06A
	Nominal* 1" x 2" x 8' (Provision for drainage beneath batten with min 1/4" thick decay-resistant riser at each fastener)	Alternates: Corrosive resistant metal, or other man made material that meets the approval of the local building official and/or a valid and recognized batten system.

Nominal*: Refer to IBC, Chapter 23 (WOOD), SECTION 2302 (DEFINITIONS).

Allowable Loads: When using counter battens, refer to Table 2 for additional load considerations.

Batten Fastening: 24" OC to the deck with 8d corrosive resistant nails.
12" OC to the deck with No 16 gauge by 7/16-inch crown by 1 1/2-inch long corrosive-resistant staples.
Once the batten is installed, it becomes part of the deck for fastening purposes.

Climatic Conditions: In dry/cool humidity climates, moisture resistant battens are not required. Consideration should be given to lower slope roofs that are susceptible to wind driven snow and rain. Optional upgrades should be considered.

NOTE: In Cool/Humid climates raised, scalloped, counter or other batten systems that provide positive drainage are required.



Drawing shown depicts the application of all tile profiles. Unless otherwise noted, it would apply to either concrete or clay tiles.

MC-01

IDENTIFICATION OF ROOF AREAS

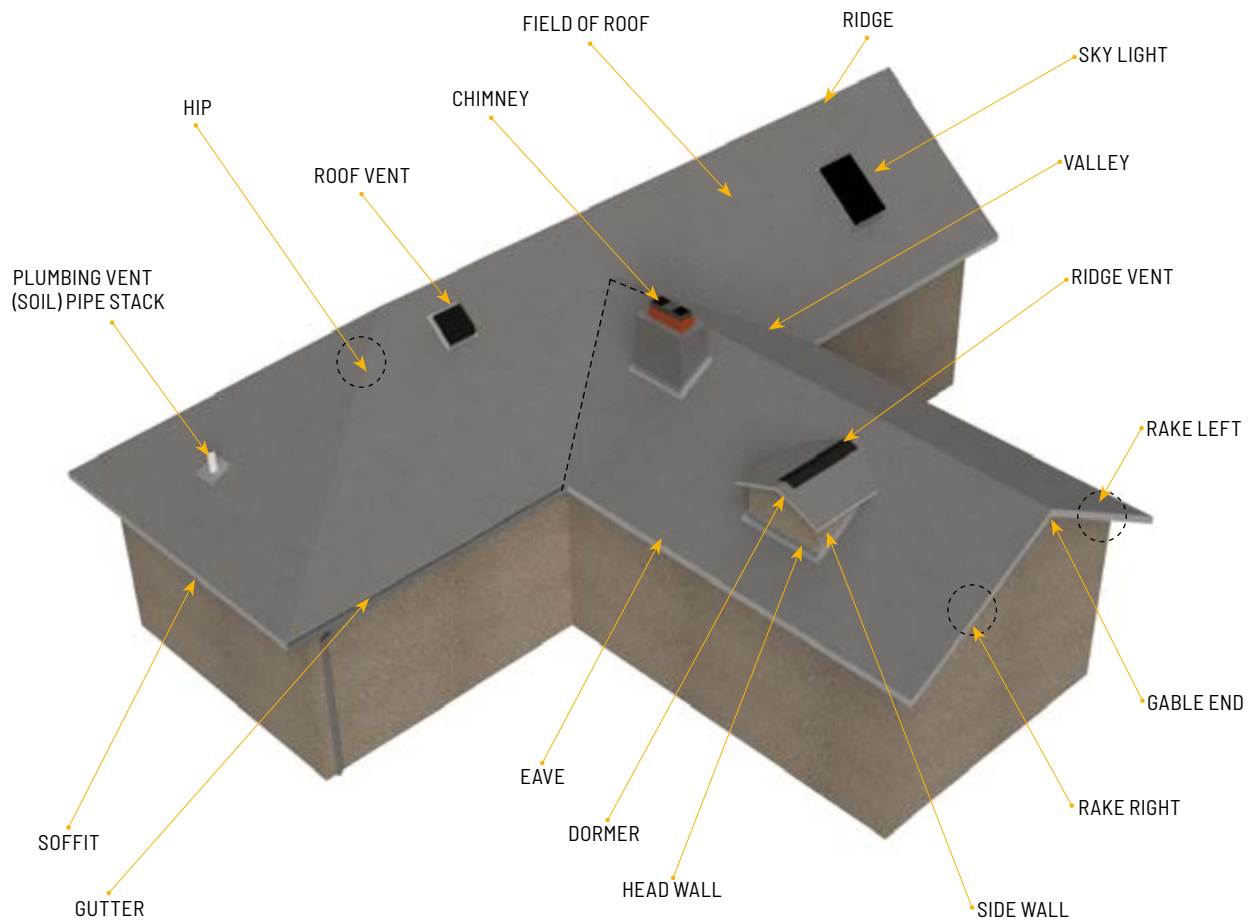

CHIMNEY: A penetration constructed of stone, masonry, prefabricated metal, or a wood framed chase containing one or more flues, projecting through and above the roof.

DORMER: A frame projection through the sloping plane of a roof.

EAVE: A projecting edge of a roof that extends beyond the supporting wall.

FIELD OF ROOF: The central or main portion of a roof, excluding the perimeter and flashings.

GABLE: A triangular portion of the end wall of a building directly under the sloping roof and the eave line.

GUTTER: A channeled component installed along the downslope perimeter of a roof to the drain leaders or down spout.

HIP: The inclined external angle formed by the intersection of two sloping roof planes.

HEAD WALL: Flashing installed at a horizontal roof to wall.

RAKE EDGE: The sloped edge of a roof at or adjacent to the first rafter or truss.

RAKE: The area used to cover the intersection between the gable and end of roof.

RIDGE: The highest point of a roof, represented by a horizontal line where two roof areas, intersect, running the length of the area

RIDGE VENT: A roof accessory designed for use as a vent along the ridge of a roof system.

ROOF VENT: A penetration through the roof to allow ventilation.

SKYLIGHT: A roof accessory, set over an opening in the roof, designed to admit light, normally transparent, and mounted on a raised curb.

SOFFIT: The underside of any exterior overhanging section of the roof eave.

PLUMBING (SOIL) STACK: A sanitation pipe that penetrates the roof; used to vent plumbing fixture(s).

VALLEY: The internal angle formed by the intersection of two sloped roofing planes.

Drawing shown depicts the application of all tile profiles. Unless otherwise noted, it would apply to either concrete or clay tiles.

SINGLE LAYER UNDERLAYMENT

MC-01A

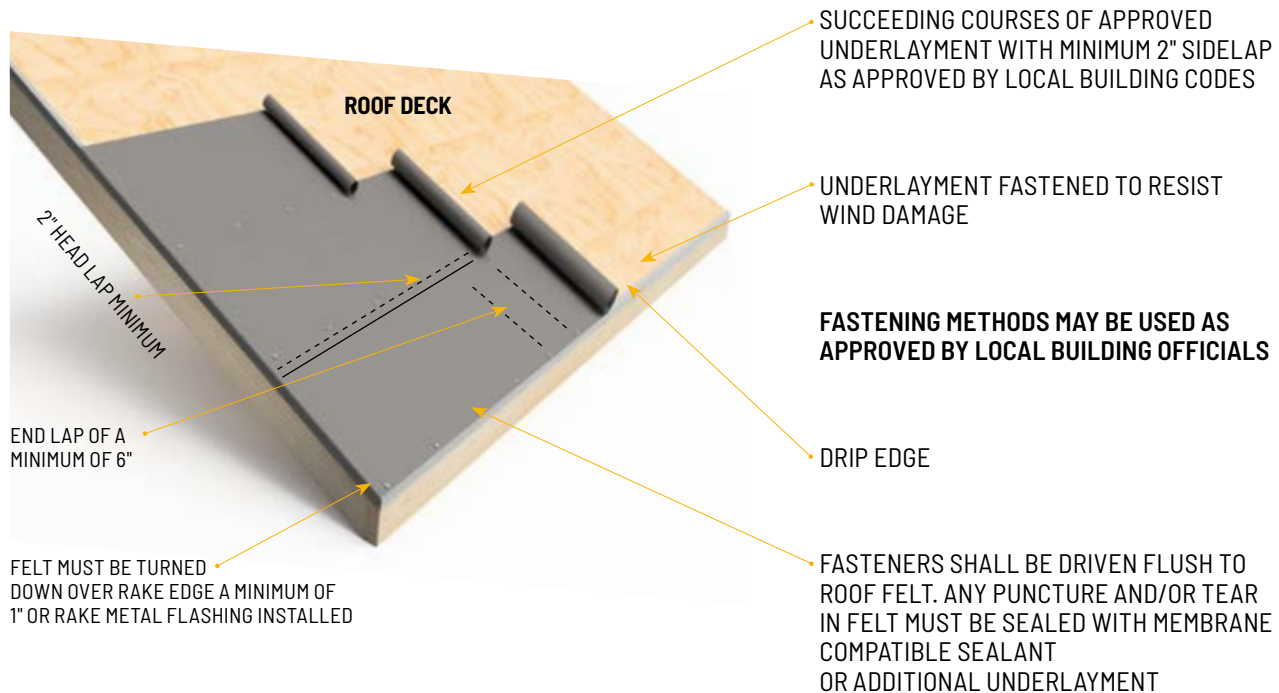

ICE DAM PROTECTION WHERE REQUIRED

NOTE: Roof slopes below shall have an approved built up roof membrane applied in accordance with Table 1A, or a single ply roof membrane system, or other multi-ply-underlayment system(s) approved by the local building official.

NOTES:

1. Ensure that the roof deck is properly fastened, clean and smooth before underlayment and roof tiles are applied.
2. Verify that the roof deck has no significant delamination, warp-age, etc. Check roof deck decay or damage.
3. Make sure repairs are made to roof deck as necessary to meet local building codes.
4. Most problems with water-shedding roof installations occur from water that migrates through improper flashing of the tile, wind-driven rain or ice damming. Because of this possibility, the underlayment is critical to the success of the roof system.
5. For recommended underlayment and fastening, see Page 13, Table 1A, 1B & 1C.
6. Underlayment should extend a minimum of 4" up the vertical wood blocking or wall. Laps should be a minimum of 6" end lap (vertical lap) and 2" headlap.

Drawing shown depicts the application of all tile profiles. Unless otherwise noted, it would apply to either concrete or clay tiles.

MC-01B

DOUBLE LAYER UNDERLAYMENT

(Required for 3:12 < Roof Slope < 4:12, Optional Upgrade 4:12 And Above)

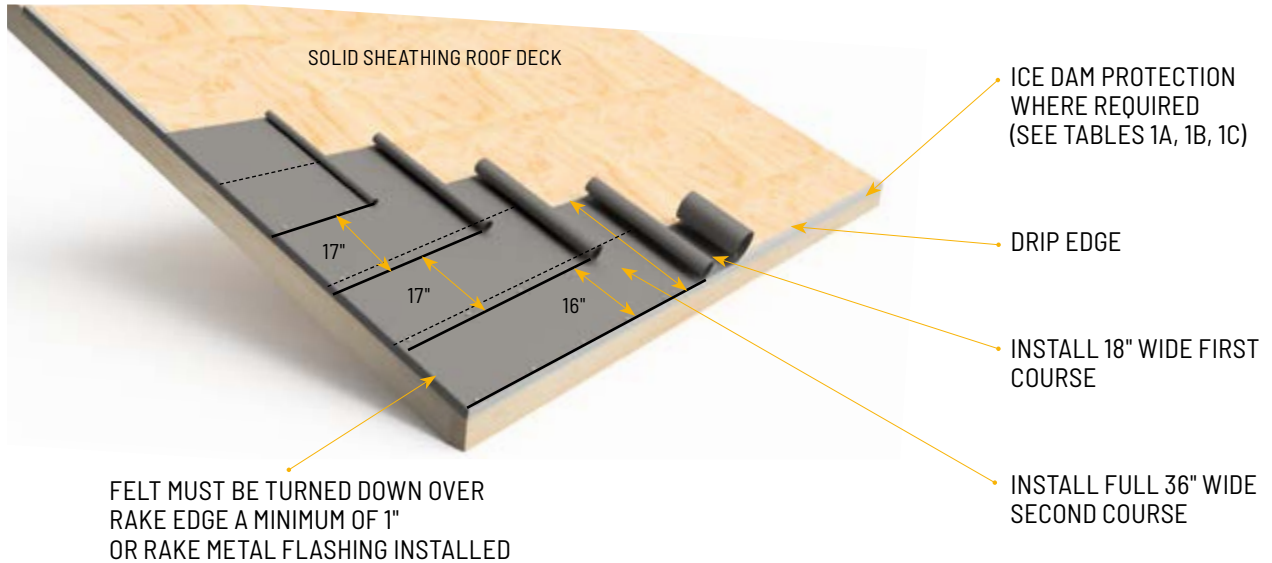
**UNDERLAYMENT AS APPROVED BY LOCAL BUILDING OFFICIAL**

DRAWING DEPICTS TYPICAL 36" WIDE ROLLS LAPPED 19"

NOTES:

1. Ensure that the roof deck is properly fastened, clean and smooth before underlayment and roof tiles are applied.
1. Verify that the roof deck has no significant delamination, warp-age, etc. Check roof deck decay or damage.
2. Make sure repairs are made to roof deck as necessary to meet local building codes.
3. Apply a half sheet parallel to eave. Fasten underlayment sufficient to hold the felt in place.
4. Completely cover the starter sheet with a full-width sheet.
5. Most problems with water-shedding roof installations occur from water that migrates through improper flashing of the tile, wind-driven rain or ice damming. Because of this possibility, the underlayment is critical to the success of the roof system.
6. Underlayment should extend a minimum of 4" up the vertical wood blocking or wall.
7. Lap succeeding sheets to ensure double layers over the entire roof. End laps (vertical lapse) shall be a minimum of 6".

Drawing shown depicts the application of all tile profiles. Unless otherwise noted, it would apply to either concrete or clay tiles.

TILE PENETRATION FLASHING

MC-02

(Shows Required Two-Step Deck and Tile Flashing)

STEP 1 - DECK FLASHING

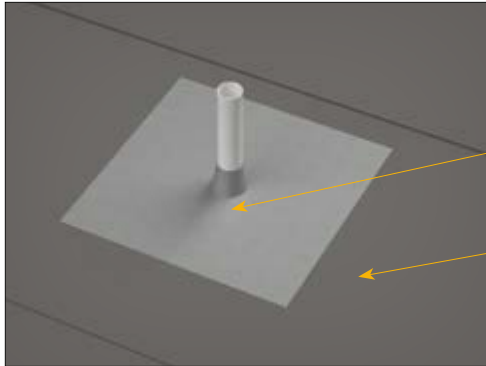

PENETRATION COVERED WITH DECK FLASHING

UNDERLAYMENT

STEP 2 - UNDERLAYMENT COURSING

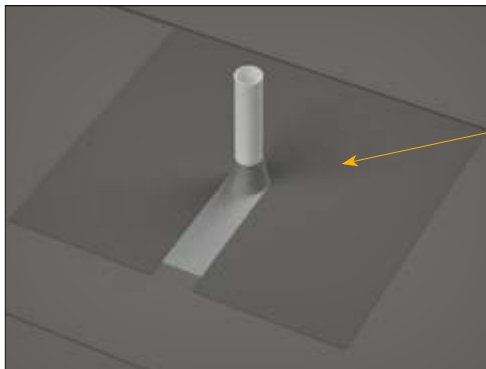

PREFORMED FLASHING INTEGRATED INTO UNDERLAYMENT (INSTALLED TO PREVENT MOISTURE FROM PENETRATING ROOF DECK. OPTIONAL STRIPPING, THREE COURSING WITH ASPHALT ROOF CEMENT AND REINFORCING FABRIC FOR INSTALLATION OF DECK FLASHING WHEN PERMITTED BY LOCAL BUILDING OFFICIAL)

STEP 3 - TILE FLASHING

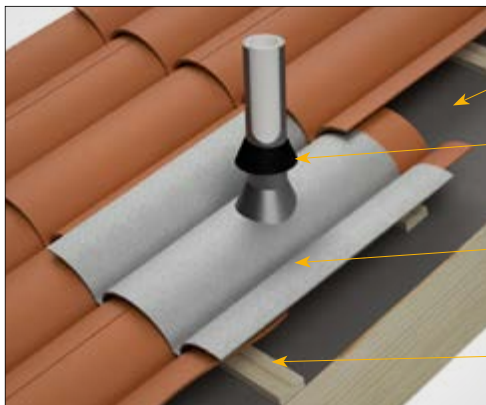

UNDERLAYMENT INSTALLED OVER DECK FLASHING, COURSED UNDER LAYER ABOVE.

STORM COLLAR ON CONE STYLE FLASHING

PROFILE TILE FLASHING (CONFORM SHEET LEAD OR OTHER MALLEABLE FLASHING TO PROFILE OF TILE) TO MAINTAIN DRAINAGE TO TOP OF TILE

BATTEN (WHERE REQUIRED)

ALL PENETRATIONS SHOULD BE LOCATED IN SUCH A MANNER AS TO NOT IMPEDE FLASHINGS AT ROOF TRANSITIONS

NOTES:

1. For recommended underlayment and fastening, see Page 13, Table 1A, 1B & 1C
2. All penetrations require a deck and tile flashing.
3. Tile flashings shall extend onto the tile a minimum of 4" on flat tile and a minimum of 1" past the crown of the tile of a profiled tile.
4. Dimensions shown are minimum and intended to be approximate to allow for reasonable tolerances due to field conditions.
5. For flat tile, a rigid flashing material may be used.

Drawing shown depicts the application of all tile profiles. Unless otherwise noted, it would apply to either concrete or clay tiles.

MC-03

VALLEY UNDERLAYMENTS**WOVEN UNDERLAYMENT (METAL FLASHING NOT SHOWN)****NOTE:**

1. The underlayment options shown on MC-03 or MC-03A are acceptable options for any metal configuration.
2. See MC-12B for additional considerations.
3. For recommended underlayment and fastening, see Page 13, Table 1A, 1B & 1C.

Drawing shown depicts the application of all tile profiles. Unless otherwise noted, it would apply to either concrete or clay tiles.

VALLEY UNDERLAYMENTS

MC-03A

OVERLAPPING UNDERLAYMENT

This method not to be used with standing hem valley metal

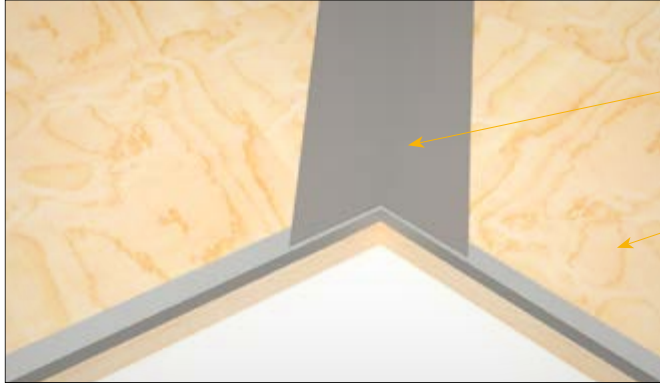

36" BLEEDER STRIP

ROOF DECK

NOTE:

Underlayment options shown in MC-03 or MC-03A are acceptable options for any code approved metal. See MC-12B for additional considerations.

UNDERLAYMENT TO LAP OVER VALLEY METAL A MINIMUM OF 2"

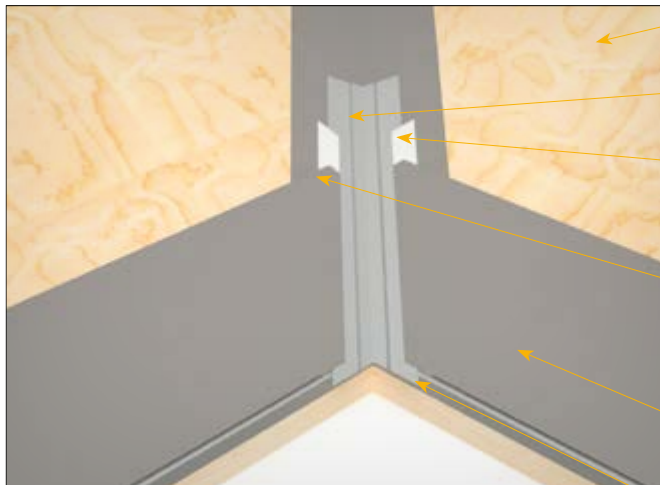

ROOF DECK

VALLEY FLASHINGS

OPTIONAL: SELF ADHERING POLYMER MODIFIED ASPHALT MEMBRANE ON EACH SIDE TO COVER FLASHING FLANGE

CUT TOP CORNER OF UNDERLAYMENT TO ENSURE PROPER DIVERSIONS OF WATER INTO THE VALLEY METAL

ROOF UNDERLAYMENT

PICTURE OF NOTCHED CORNER OF FELT



VALLEY FLASHING (EXTEND ENTIRE WIDTH OF VALLEY METAL BEYOND ROOF EDGE)

NOTES:

1. For recommended underlayment and fastening, see Page 13, Table 1A, 1B & 1C

MC-04

LAYOUT OPTIONS - BATTENS

FOR TILES WITH PROTRUDING ANCHOR LUGS
(Do not mix batten options on a roof)



DIRECT DECK - NO BATTENS USED IN DIRECT DECK APPLICATIONS. CAN BE EITHER STYLE OF TILE



OPTIONAL METHODS:
 BATTENS WITH SHIMS
 BATTENS WITHOUT SHIMS

4 FT MAX. LENGTH WITH 1/2" SEPARATION THAT MAY BE VERTICALLY ALIGNED OR OFFSET

DISTANCE DETERMINED FOR MINIMUM 3" HEADLAP BASED ON TILE LENGTH

OPTIONAL PORTED BATTEN: MIN 1/2" WIDE X 1/4" DEEP WITH DRAINAGE PORTS MIN 2 FT. ON CENTER. OPTIONAL RAISED OR ELEVATED BATTEN SYSTEMS WITH CODE APPROVAL ARE ALLOWED.

NOTE:

Using a full tile, determine desired overhang at eave and snap a horizontal chalk line across roof at the head of a tile or top of batten. Consider tile dimensions, eave closure and eave/gutter detail to determine desired overhang. First row chalkline must adjust for direct to deck or batten installation.

NOT TO SCALE, FOR VISUAL PURPOSES ONLY. SEE MANUFACTURER OF BATTENS FOR ADDITIONAL INFORMATION



OPTIONAL PORTED BATTEN: MIN 1/2" WIDE 1/4" DEEP DRAINAGE PORT MINIMUM OF 2 FT. ON CENTER



OPTIONAL BATTENS WITH SHIMS, RAISED PADS



OPTIONAL BATTENS WITH SCALLOP OR OTHER DRAINAGE DESIGNS

NOTES:

1. For recommended underlayment and fastening, see Page 13, Table 1A, 1B & 1C.
2. Battens shall not be less than nominal inch by inch or other code approved products.
3. Battens shall be no longer than 48" and separated with 1/2" minimum gaps at ends to allow for drainage. An alternative method permits the use of longer batten strips with shims of minimum 1/4" thick decay resistant material (e.g. asphalt shingle, woods strips or cap sheet) at fastener to provide drainage, or other methods as approved by local building official.
4. Fasten battens a minimum of 24" on center with minimum 8d corrosion-resistant nails penetrating through decking or into structural framing. Batten attachment at 12" on center with staples a minimum of 1-1/2" long 7/16" crown. No 16 gauge corrosion-resistant allowing for a 3/4" penetration into roof deck or protrude min 1/4" through sheathing which ever is less or 24" centers if fastening directly to structural framing. Consideration should be given to climate and roof orientation to determine if it is beneficial to specify/use vertical battens over underlayment, with horizontal battens secured over vertical battens.
5. See Table 2 and Table 3 for additional batten considerations.

Drawing shown depicts the application of all tile profiles. Unless otherwise noted, it would apply to either concrete or clay tiles.

COUNTER BATTEN INSTALLATION SYSTEM

MC-05

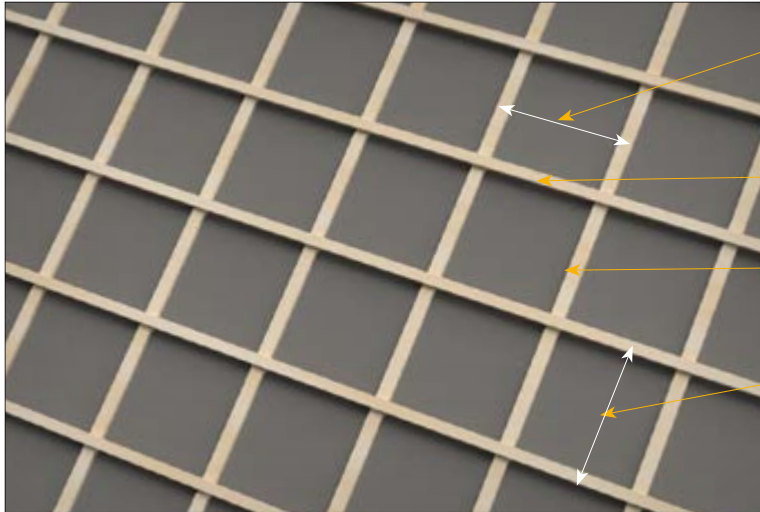

SEE TABLE 2 FOR SIZE AND SPACING OF VERTICAL BATTENS (24" MAX SPACING BETWEEN VERTICAL BATTENS)

HORIZONTAL BATTENS

VERTICAL BATTENS MINIMUM 1/4" THICKNESS

DISTANCE DETERMINED FOR 3" HEADLAP BASED ON TILE LENGTH WHERE FASTENING TO FRAMING MEMBER IS DESIRED, MARK AFTER LOCATION AS FELT IS BEING APPLIED

NOTE:

Consideration should be given to climate roof orientation to determine if it is beneficial to specify/use vertical battens over underlayment, with horizontal battens secured over the vertical battens.

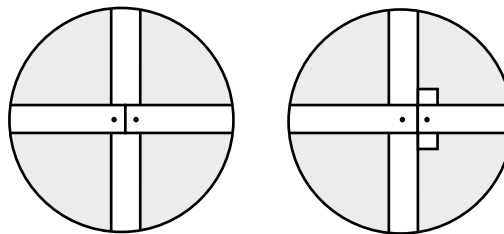

BATTEN TERMINATION (OPTIONAL) SEE TABLE 3

NOTES:

1. For recommended underlayment and fastening, see Page 13, Table 1A, 1B & 1C.
2. Horizontal batten shall be sufficient to fully engage protruding anchor lugs of the tile.
3. See Table and for additional information.
4. Fasten battens a minimum of 24" on center with minimum 8d corrosion-resistant nails penetrating through decking or into structural framing. Batten attachment at 12" on center with staples a minimum of 1 1/2" long 7/16" crown, No 16 gauge corrosion-resistant allowing for a penetration into roof deck or protrude 3/4" min through sheathing which ever is less or on 24" centers if fastening directly to structural framing.

Drawing shown depicts the application of all tile profiles. Unless otherwise noted, it would apply to either concrete or clay tiles.

MC-06

VERTICAL BATTENS FOR DEEP TROUGH VALLEY

Any flashing with outside edges raised to the height of the vertical or horizontal battens

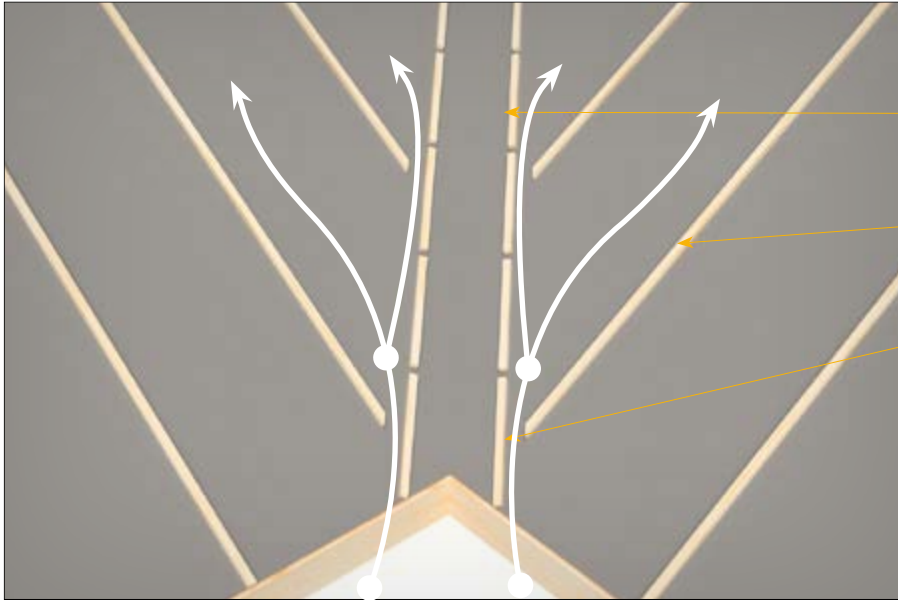

EDGE STRIP

VERTICAL BATTEN

PROVIDE 2" MINIMUM CLEARANCE FOR AIRFLOW AND DRAINAGE

REFER TO MC-03 FOR WOVEN UNDERLAYMENT

REFER TO MC-17 FOR FINISH DETAIL

REFER TO MC-17B FOR DEEP TROUGH DETAIL

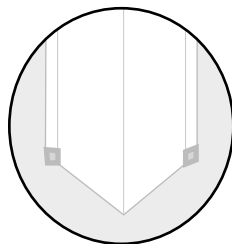

DEEP TROUGH VALLEY

NOTES:

1. For recommended underlayment and fastening, see Page 13, Table 1A, 1B & 1C
2. Consideration should be given to climate and roof orientation to determine if it is beneficial to specify/use vertical battens over underlayment, with horizontal battens secured over vertical battens.

Drawing shown depicts the application of all tile profiles. Unless otherwise noted, it would apply to either concrete or clay tiles.

VERTICAL BATTENS FOR STANDARD VALLEY AND HIPS

MC-06A

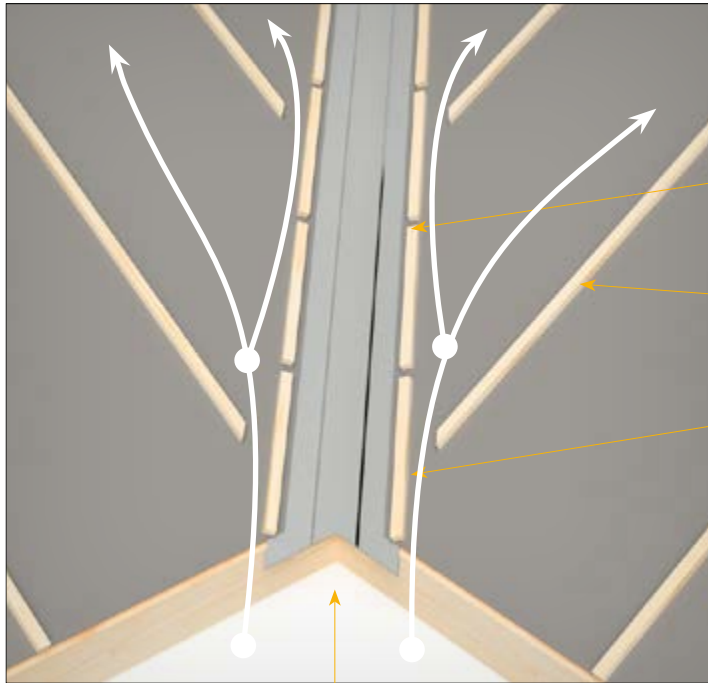

BATTENS WITH 2" GAPS FOR AIR FLOW AND DRAINAGE AT MIN 48" O.C.

VERTICAL BATTEN

PROVIDE MINIMUM 2" GAP FOR AIRFLOW AND DRAINAGE

REFER TO MC-03A FOR OVERLAPPING UNDERLAYMENT

REFER TO MC-17B FOR FINISH DETAIL

VALLEY FLASHING

(EXTEND ENTIRE WIDTH OF VALLEY METAL BEYOND ROOF EDGE EQUAL TO OVERHANG OF TILE)

NOTES:

1. For recommended underlayment and fastening, see Page 13, Table 1A, 1B & 1C
2. Horizontal battens shall be not less than 1" x 2" or code approved equal.
3. Consideration should be given to climate and roof orientation to determine if it is beneficial to specify/use vertical battens over underlayment, with horizontal battens secured over vertical battens.
4. See Table and Table for additional considerations.

Drawing shown depicts the application of all tile profiles. Unless otherwise noted, it would apply to either concrete or clay tiles.

MC-07

ESTABLISH VERTICAL ALIGNMENT

Based on a roof tile that has an exposed width of 11 1/2" individually or 34 1/2" for three tiles.

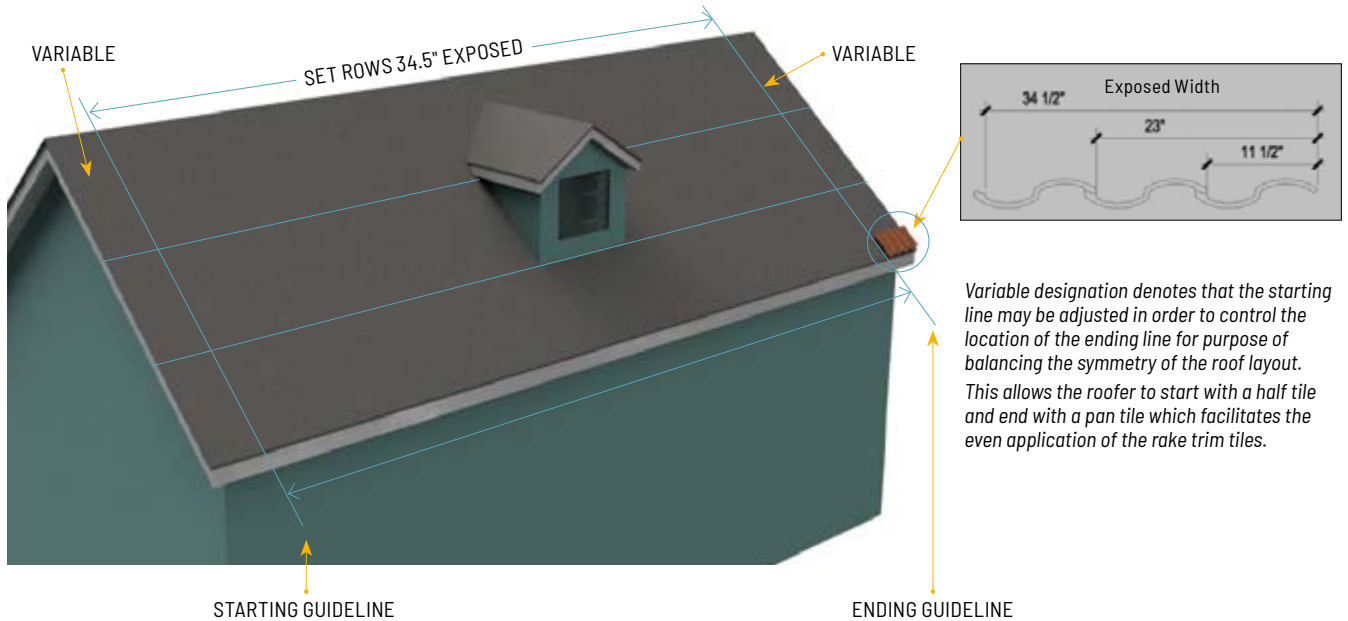

Variable designation denotes that the starting line may be adjusted in order to control the location of the ending line for purpose of balancing the symmetry of the roof layout. This allows the roofer to start with a half tile and end with a pan tile which facilitates the even application of the rake trim tiles.

Appendix A

Vertical alignment on interlocking tiles is, for the most part, controlled by the natural seat of the interlocking channels of the adjacent tiles. It is important however to establish true vertical alignment prior to application of field tiles to assure a symmetrical installation. Proper roof layout greatly enhances the appearance and performance of the installed roof and serves to simplify and speed the application of the tiles. A few minutes devoted to layout at the beginning of the job can result in significant savings of time and effort as the job progresses.

On a gable roof installation, the first vertical guideline is established by installing the first three tile of the eave course and measuring the distance from the leading edge of the third tile to the rake. This increment is then marked at the ridge course and a chalk line is snapped to delineate the vertical guide.

The exposed width dimension of the tile is then determined and measured from the vertical gable as frequently as needed to maintain proper alignment. Most often this measurement is marked in three-tile increments. Vertical lines shall be perpendicular to the eave.

Mark the point at the eave line as close to the center of the hip as possible. Measure a point away from either side of the center point (5'-10') if possible, making sure that both marks are the same distance from the center line. Using a tape measure or lines of the exact same length, swing an arc away from each mark to intersect as high on the hip as possible. Intersection point of the arc represents the high point of the vertical line above the mark made near the center of the eave line. A chalk line may be snapped to provide vertical reference. Incremental measurements may then be taken in either direction from this center line to provide guidance for vertical alignment.

On small hip sections, careful attention to horizontal alignment and proper tile placement is usually adequate to maintain vertical alignment.

On larger roof sections, it is helpful to establish solid vertical alignment to ensure uniform appearance and ease of application.

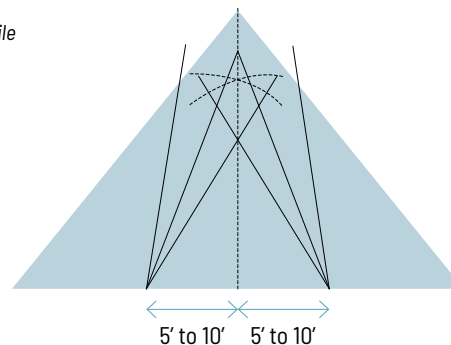
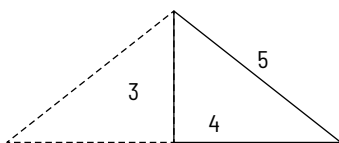

Drawing shown depicts the application of all tile profiles. Unless otherwise noted, it would apply to either concrete or clay tiles.

ROOF LAYOUT

MC-08

Utilizing specially marked measuring tape

To achieve optimum beauty, the area between the eave and the ridge should be divided into equal tile courses, when possible. Minimum 3" overlap must be maintained for all tiles unless design of tile precludes. (see MC-04 for batten applications)

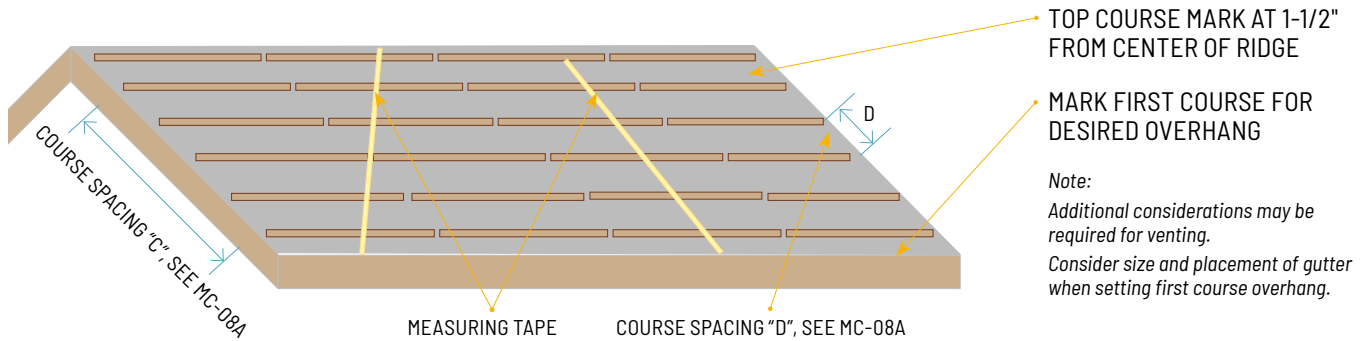

ROOF LAYOUT FOR CLAY DIAGONAL CUT ONE-PIECE S TILE

1.

HORIZONTAL LAYOUT

- Using a full tile, determine desired overhang at eave and snap horizontal chalk line across roof at head end of tile or top batten. Use of rain gutter and eave closures should be considered in determining overhang.
- At top of roof deck, mark a reference point by measuring 1-1/2" from the center of the ridge, plus the distance of a full course (i.e. 15" for a 18" tile length tile).
- Measure up the roof slope to the reference point and divide by the manufacturers maximum exposure in an effort to determine if the roof section will terminate with a full tile.
- Mark roof deck for each course of tile and snap chalk lines over entire roof.
- If roof section does not terminate with a full tile at the ridge, decrease the course exposure in small increments (typically 1/4") in an attempt to finish with a full tile at the ridge.
- If the last course does not terminate with a full tile, cut to dimension, as required and fasten with a mechanical fastener or approved fastening method.

VERTICAL LAYOUT

- To ensure proper vertical alignment, determine the manufacturers stated maximum on-center spacing requirements and snap chalk lines as reference points, typically the inside of the tile.
- For gable end roof sections, determine the proper distance from the left and right rakes and mark the eave and ridge section to align the edge of the tiles.
- Measure between the two marks and divide by the manufacturers stated maximum on-center spacing. If required, decrease the on-center spacing, slightly in an effort to terminate a full tile at gable end(s). Ensure that the tile are within the manufactures minimum/maximum on-center spacing requirements.

Note: Tiles are allowed, by ASTM C1167/C1492 for a plus or minus 5% variance from the manufacturers stated "nominal dimensions". It is the installer's responsibility to verify the "delivered" roof tiles dimensions prior to commencing roof layout and to ensure that the tile is installed with in the manufacturers minimum headlap and on-center spacing requirements. Most diagonal-cut tile will allow slight course exposure adjustments, typically 1/4" per tile.

Drawing shown depicts the application of all tile profiles. Unless otherwise noted, it would apply to either concrete or clay tiles.



MC-08A

ROOF LAYOUT—QUICK REFERENCE

Course spacing table - for tiles 16 1/2" to 17" in length

To achieve optimum beauty, the area between the eave and ridge should be divided into equal courses, when possible. Minimum 3" headlap must be maintained for all tiles unless design precludes.

17" ONLY →
 16 1/2" - NOT TO EXCEED 13 1/2" →

	12 1/2"	12 5/8"	12 3/4"	12 7/8"	13"	13 1/8"	13 1/4"	13 3/8"	13 1/2"	13 5/8"	13 3/4"	13 7/8"	14"
2' 1"	2' 1-1/4"	2' 1-1/2"	2' 1-3/4"	2' 2"	2' 2 1/4"	2' 2 1/2"	2' 2 3/4"	2' 3"	2' 3 1/4"	2' 3 1/2"	2' 3 3/4"	2' 4"	
3' 1 1/2"	3' 1 7/8"	3' 2 1/4"	3' 2 5/8"	3' 3"	3' 3 3/8"	3' 3 3/4"	3' 4 1/8"	3' 4 1/2"	3' 4 7/8"	3' 5 1/4"	3' 5 5/8"	3' 6"	
4' 2"	4' 2 1/2"	4' 3"	4' 3 1/2"	4' 4"	4' 4 1/2"	4' 5"	4' 5 1/2"	4' 6"	4' 6 1/2"	4' 7"	4' 7 1/2"	4' 8"	
5' 2 1/2"	5' 3 1/8"	5' 3 3/4"	5' 4 3/8"	5' 5"	5' 5 5/8"	5' 6 1/4"	5' 6 7/8"	5' 7 1/2"	5' 8 1/8"	5' 8 3/4"	5' 9 3/8"	5' 10"	
6' 3"	6' 3 3/4"	6' 4 1/2"	6' 5 1/4"	6' 6"	6' 6 3/4"	6' 7 1/2"	6' 8 1/4"	6' 9"	6' 9 3/4"	6' 10 1/2"	6' 11 1/4"	7' 0"	
7' 3 1/2"	7' 4 3/8"	7' 5 1/4"	7' 6 1/8"	7' 7"	7' 7 7/8"	7' 8 3/4"	7' 9 5/8"	7' 10 1/2"	7' 11 3/8"	8' 1/4"	8' 1 1/8"	8' 2"	
8' 4"	8' 5"	8' 6"	8' 7"	8' 8"	8' 9"	8' 10"	8' 11"	9' 0"	9' 1"	9' 2"	9' 3"	9' 4"	
9' 4 1/2"	9' 5 5/8"	9' 6 3/4"	9' 7 7/8"	9' 9"	9' 10 1/8"	9' 11 1/4"	10' 3/8"	10' 1 1/2"	10' 2 5/8"	10' 3 3/4"	10' 4 7/8"	10' 6"	
10' 5"	10' 6 1/4"	10' 7 1/2"	10' 8 3/4"	10' 10"	10' 11 1/4"	11' 1/2"	11' 1 3/4"	11' 3"	11' 4 1/2"	11' 5 1/2"	11' 6 3/4"	11' 8"	
11' 5 1/2"	11' 6 7/8"	11' 8 1/4"	11' 9 5/8"	11' 11"	12' 3/8"	12' 1 3/4"	12' 3 1/8"	12' 4 1/2"	12' 5 7/8"	12' 7 1/4"	12' 8 5/8"	12' 10"	
12' 6"	12' 7 1/2"	12' 9"	12' 10 1/2"	13' 1 1/2"	13' 0"	13' 1 1/2"	13' 3"	13' 4 1/2"	13' 6"	13' 7 1/2"	13' 10 1/2"	14' 10"	
13' 6 1/2"	13' 7 1/8"	13' 9 3/4"	13' 11 3/8"	14' 1"	14' 2 5/8"	14' 4 1/4"	14' 5 7/8"	14' 7 1/2"	14' 9 1/8"	14' 10 3/4"	15' 3/8"	15' 2"	
14' 7"	14' 8 3/4"	14' 10 1/2"	15' 1/4"	15' 2"	15' 3 3/4"	15' 5 1/2"	15' 7 1/4"	15' 9"	15' 10 3/4"	16' 1/2"	16' 2 1/4"	16' 4"	
15' 7 1/2"	15' 9 1/8"	15' 11 1/4"	16' 1 1/8"	16' 3"	16' 4 7/8"	16' 6 3/4"	16' 8 5/8"	16' 10 1/2"	17' 3/8"	17' 2 1/4"	17' 4 1/8"	17' 6"	
16' 8"	16' 10"	17' 0"	17' 2"	17' 4"	17' 6"	17' 8"	17' 10"	18' 0"	18' 2"	18' 4"	18' 6"	18' 8"	
17' 8 1/2"	17' 10 5/8"	18' 3/4"	18' 2 7/8"	18' 5"	18' 7 1/8"	18' 9 1/4"	18' 11 3/8"	19' 1 1/2"	19' 3 5/8"	19' 5 3/4"	19' 7 7/8"	19' 10"	
18' 9"	18' 11 1/4"	19' 1 1/2"	19' 3 3/4"	19' 6"	19' 8 1/4"	19' 10 1/2"	20' 3/4"	20' 3"	20' 5 1/4"	20' 7 1/2"	20' 9 3/4"	21' 0"	
19' 9 1/2"	19' 11 7/8"	20' 2 1/4"	20' 4 5/8"	20' 7"	20' 9 3/8"	20' 11 3/4"	21' 2 1/8"	21' 4 1/2"	21' 6 7/8"	21' 9 1/4"	21' 11 5/8"	22' 2"	
20' 10"	21' 1/2"	21' 3"	21' 5 1/2"	21' 8"	21' 10 1/2"	22' 1"	22' 3 1/2"	22' 6"	22' 8 1/2"	22' 11"	23' 1 1/2"	23' 4"	
21' 10 1/2"	22' 1 1/8"	22' 3 3/4"	22' 6 3/8"	22' 9"	22' 11 5/8"	23' 2 1/4"	23' 4 7/8"	23' 7 1/2"	23' 10 1/8"	24' 3/4"	24' 3 3/8"	24' 6"	
22' 11"	23' 1 3/4"	23' 4 1/2"	23' 7 1/4"	23' 10"	24' 3/4"	24' 3 1/2"	24' 6 1/4"	24' 9"	24' 11 3/4"	25' 2 1/2"	25' 5 1/4"	25' 8"	
23' 11 1/4"	24' 2 3/8"	24' 5 1/4"	24' 8 1/8"	24' 11"	25' 1 7/8"	25' 4 3/4"	25' 7 5/8"	25' 10 1/2"	26' 1 3/8"	26' 4 1/4"	26' 7 7/8"	26' 10"	
25' 0"	25' 3"	25' 6"	25' 9"	26' 0"	26' 3"	26' 6"	26' 9"	27' 0"	27' 3"	27' 6"	27' 9"	28' 0"	
26' 1/2"	26' 3 5/8"	26' 6 3/4"	26' 9 7/8"	27' 1"	27' 4 1/8"	27' 7 1/4"	27' 10 3/8"	28' 1 1/2"	28' 4 5/8"	28' 7 3/4"	28' 10 7/8"	29' 2"	
27' 1"	27' 4 1/4"	27' 7 1/2"	27' 10 3/4"	28' 2"	28' 5 1/4"	28' 8 1/2"	28' 11 3/4"	29' 3"	29' 6 1/4"	29' 9 1/2"	30' 3/4"	30' 4"	
28' 1 1/2"	28' 4 7/8"	28' 8 1/4"	28' 11 5/8"	29' 3"	29' 6 3/8"	29' 9 3/4"	30' 1 1/8"	30' 4 1/2"	30' 7 7/8"	30' 11 1/4"	31' 2 5/8"	31' 6"	
29' 2"	29' 5 1/2"	29' 9"	30' 1/2"	30' 4"	30' 7 1/2"	30' 11"	31' 2 1/2"	31' 6"	31' 9 1/2"	32' 1"	32' 4 1/2"	32' 8"	

Course Spacing "D" From MC-08

NOTES:

- Using a full tile, determine desired overhang at eave and snap horizontal chalk line across roof at head end of tile or top batten. Use of rain gutter and eave closures should be considered in determining overhang.
- Snap a horizontal chalk line at the top of the roof from center of the ridge. (Adjust for direct deck)
- In spacing guide, find column containing nearest figure to the measurement between the eave and ridge course.
- Mark both ends of roof at course spacing shown in column.
- Snap chalk lines across roof at course markings.
- Nail top batten to chalk line.

Drawing shown depicts the application of all tile profiles. Unless otherwise noted, it would apply to either concrete or clay tiles.

LOADING GUIDE (EXAMPLE)

MC-09

The method of roof lading shown on this page represents the method of tile placement for efficient application, but is not intended to suggest that this is the only method that will work. Each applicator will have personal preference for the stack location and spacing. The important aspect of tile loading is to spread the load evenly across the roof while using proper increments that assure that the proper amount of tile are roof loaded.

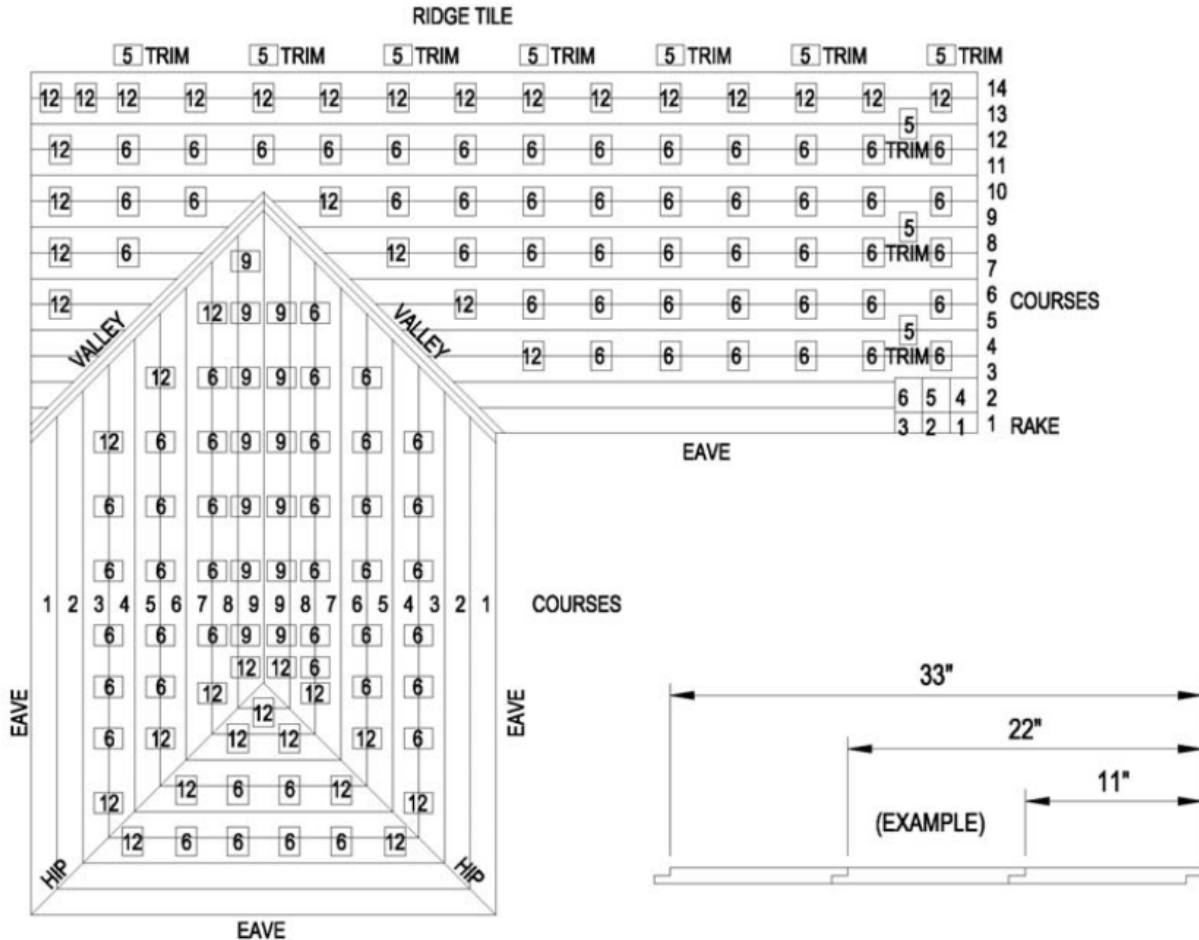

NOTES:

1. Course lines should be measured and chalked according to the roof layout plan before loading the tile.
2. Determine the appropriate number of tiles needed for each section of the roof.
3. Spacing of the tile stacks is determined by the width of the exposed tile times the number of tiles being fed per course, e.g. in the attached schematic, each stack of tiles will feed two courses, three tiles wide. If each tile is exposed 11", then the stack will be placed 33" O.C. If the stacks feed three courses, two tiles wide, then the stacks will be 22" O.C.
4. Starting with the third course from the eave, and continuing with alternate courses, distribute tiles (usually 6 per stack) over the entire roof leaving 20" from gable ends and between stacks.
5. When total number of courses is an even number, stack tiles on ridge stacks. When the total number of courses is an odd number, stack tiles on the ridge stacks.
6. On the right side of the hips and valleys, stack 12 tiles. Maintain at least 24" between tile stacks and left side of valley. Reverse for tiles laid left to right.
7. Distribute trim tiles when loading field tiles. Trim tiles are in stacks of 5 at 70" O.C. Load ridge tile on side of roof to be applied last.
8. To achieve pleasant, random blend of color for your job, care should be taken upon loading to mix tile.

Drawing shown depicts the application of all tile profiles. Unless otherwise noted, it would apply to either concrete or clay tiles.

MC-10

DOWN SLOPE EAVE

Batten/Nailers, Flashings & Risers Details

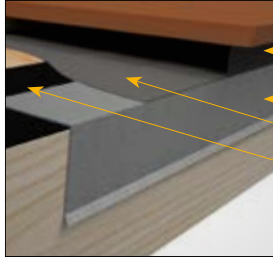

RISER



METAL CLOSURE

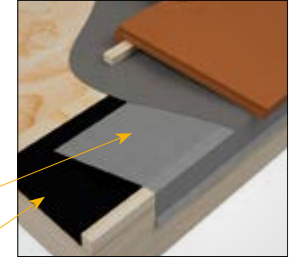

ANTI-PONDING FLASHING

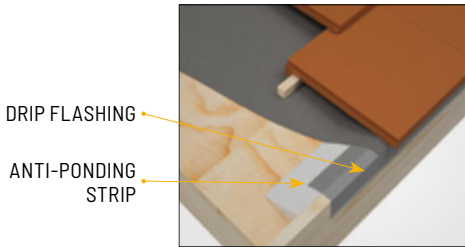

RAISED FASCIA

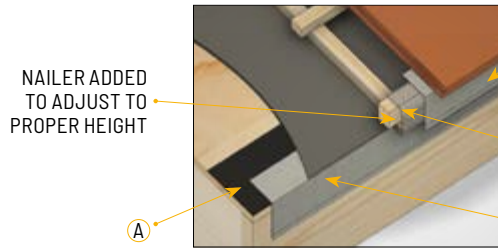

COUNTER BATTEN

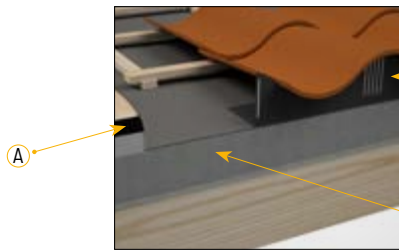

RISER WITH BIRD STOP



METAL CLOSURE

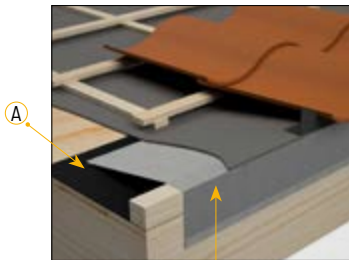

ANTI-PONDING FLASHING

ANTI-PONDING FLASHING

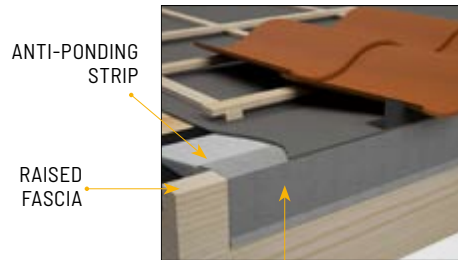

DRIP FLASHING

RAISED FASCIA

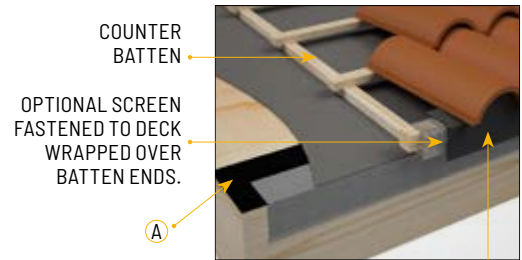

COVER METAL MIN 3/4" SPACE BETWEEN DRIP FLASHING & COVER METAL

COUNTER BATTEN

NOTES:

1. Bird stop required on High Profile tile and optional on Low and Medium profile tile unless required by local building official.
2. Bird stop may be either solid or vented.
3. Optional separator ply or sheet of No. 15 asphalt-saturated felt or other appropriate material.

Drawing shown depicts the application of all tile profiles. Unless otherwise noted, it would apply to either concrete or clay tiles.

RAISED FASCIA

MC-10A

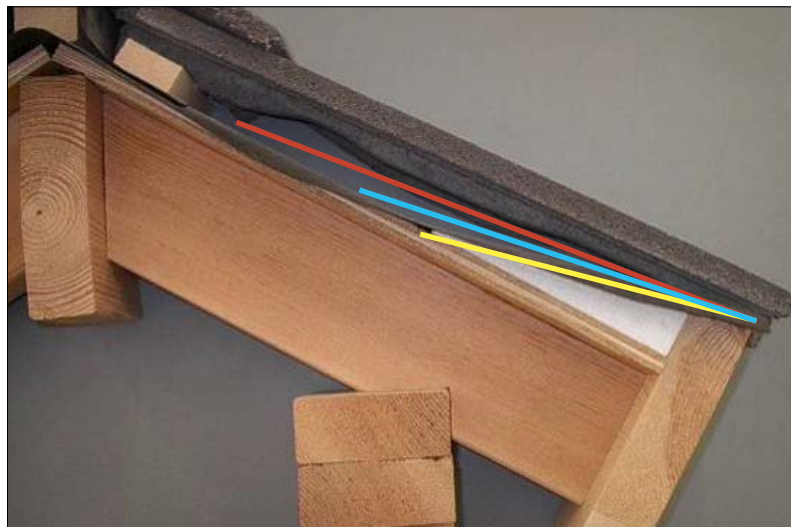
Anti-Ponding & Layering Details**NOTES:**

1. For recommended underlayment and fastening, see page 13, Table 1A, 1B & 1C
2. An anti-ponding device such as a beveled cant strip or shop-formed sheet metal is required at all raised fascia conditions to support the underlayment and provide positive drainage.
3. The tile and/or batten fasteners must penetrate a minimum into dimensional wood decking or pass through wood panel sheathing whichever is less. Once the batten is installed, it becomes part of the "deck" or substrate for tile fastening.
4. Raise fascia board above roof deck to height equal to combined thickness of batten system and thickness of one course of tile.
5. Dimensions shown are minimums and are intended to be approximate to allow for reasonable tolerances due to field.
6. Since raised fascia and starter strips create the same type of water dam situation, they both require an anti-ponding system to allow water to flow off the roof.

Drawing shown depicts the application of all tile profiles. Unless otherwise noted, it would apply to either concrete or clay tiles.

MC-10B

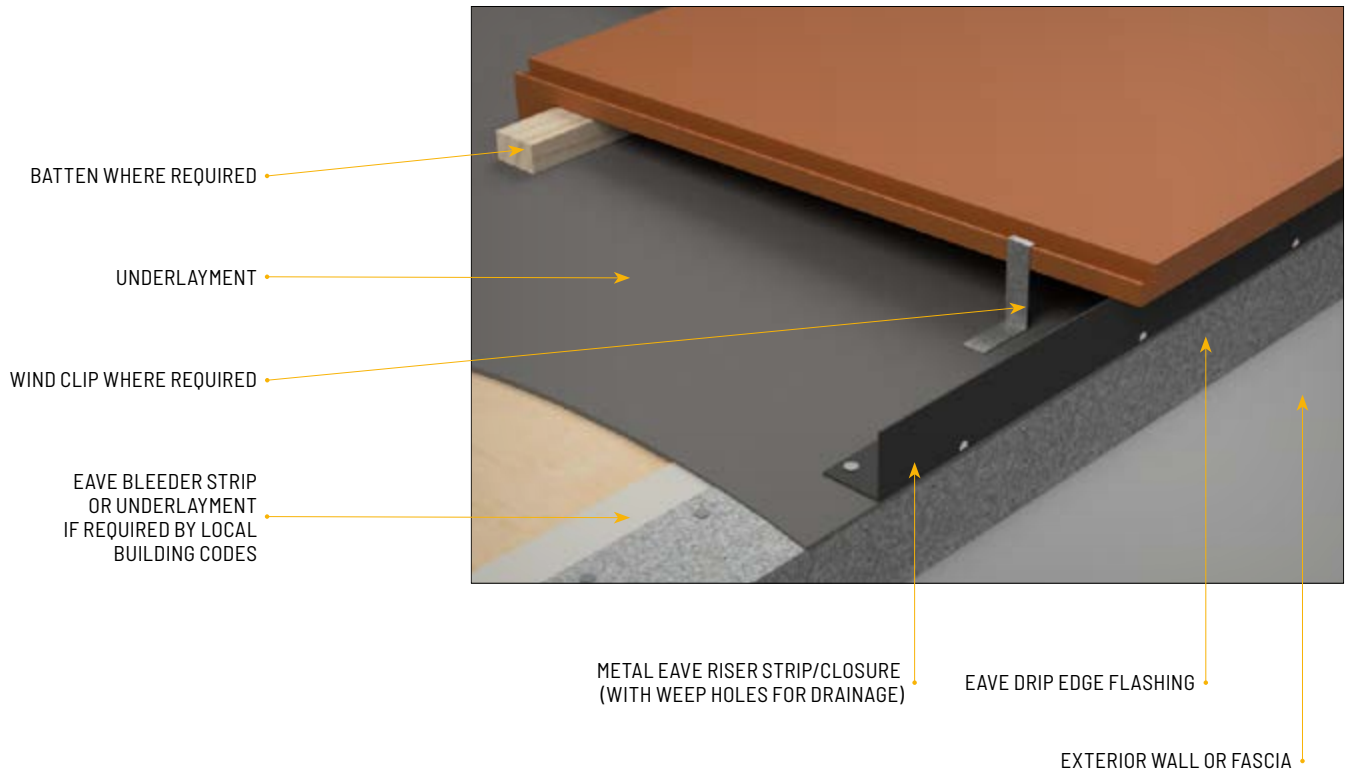
EAVE AT FLUSH WALL OR FASCIA/ZERO OVERHANG**NOTES:**

1. For recommended underlayment and fastening, see page 13, Table 1A, 1B & 1C.
2. A drip edge flashing is required for all tile profiles.
3. Battens for tiles with protruding anchor lugs are optional for slopes between and less than or equal to . Direct deck nailing attachment of tile is permissible.
4. Dimensions shown are minimums and are intended to be approximate to all for reasonable tolerances due to field conditions.

Drawing shown depicts the application of all tile profiles. Unless otherwise noted, it would apply to either concrete or clay tiles.

LOW SLOPE/VENTILATED ROOF EAVE DETAIL

MC-10C

See table 1a and 1b for underlayment requirements

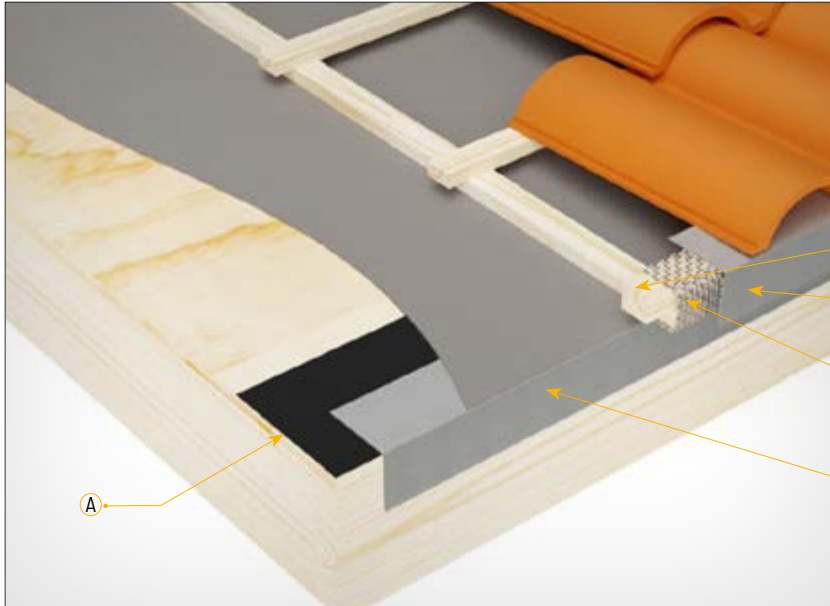

HIGH PROFILE TILE WITH BIRD STOP

- NAILER ADDED TO ADJUST TO PROPER HEIGHT
- COVER METAL (MIN. SPACE BETWEEN DRIP FLASHING & COVER METAL)
- OPTIONAL: SCREEN FASTENED TO DECK WRAPPED OVER BATTEN ENDS PER LOCAL CODE
- EAVE DRIP EDGE FLASHING



A

- VENTED BIRD STOP
- VERTICAL BATTEN. EXTEND MINIMUM PAST EAVE FOR VENTILATED ROOF
- X AS NEEDED FOR ADDITIONAL SUPPORT
- COVER METAL
- EAVE DRIP EDGE FLASHING

NOTES:

1. For recommended underlayment and fastening, see page 13, Table 1A, 1B & 1C.
2. An eave drip edge flashing is required at all downslope perimeter edges.
3. Eave closure shall be of a height equal to combined thickness of batten system and thickness of one course of tile.
4. Dimensions shown are minimums and are intended to be approximate to all for reasonable tolerances due to field conditions.
5. For extended eave, optional separator ply or sheet of No. 15 asphalt saturated felt or appropriate material.

Drawing shown depicts the application of all tile profiles. Unless otherwise noted, it would apply to either concrete or clay tiles.

MC-10D

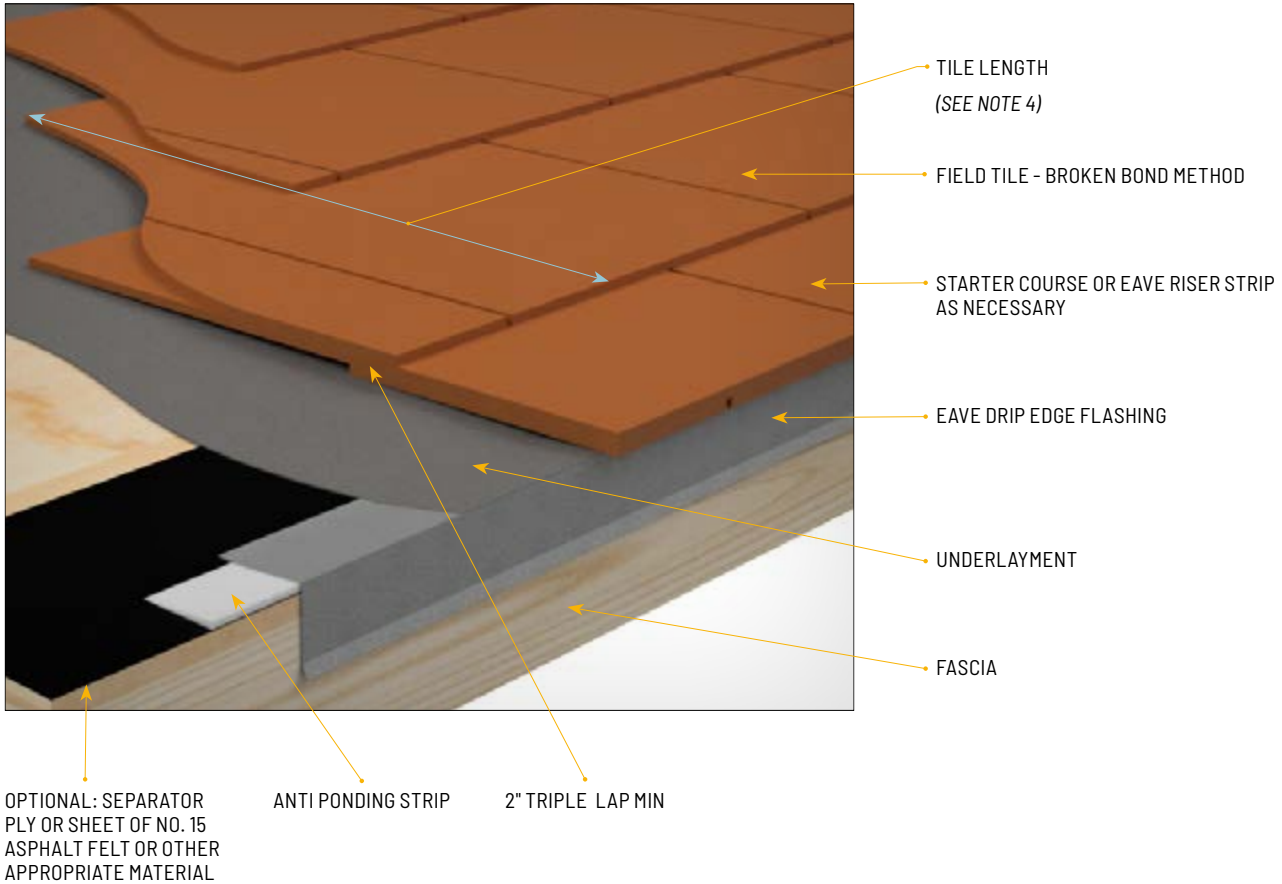
DOUBLE LAP TILE (NON-INTERLOCKING)**NOTES:**

1. For recommended underlayment and fastening, see page 13, Table 1A, 1B & 1C
2. A eave drip edge flashing is required at all downslope perimeter edges.
3. Dimensions shown are minimums and are intended to be approximate to all for reasonable tolerances due to field conditions.
4. Standard head lap equal to tile length minus 2" divided by 2.

Drawing shown depicts the application of all tile profiles. Unless otherwise noted, it would apply to either concrete or clay tiles.

HEAD WALL FLASHING

With counter flashing Z-Bar

MC-11

**NOTE:**

Openings at hips, ridges and head walls including chimneys, skylights, solar panels, and down slope horizontal abutments shall be fitted with weather blocking material to keep water on the surface of the field tile. Other methods approved by local building official will be allowed. See TRI Alliance technical bulletin at tileroofing.org

NOTES:

1. For recommended underlayment and fastening, see Page 13, Table 1A, 1B & 1C.
2. Underlayment shall extend a minimum of 4" up vertical wood blocking or wall, and is suggested to extend above wall flashing.
3. Apron flashing or other roof-to-wall closure material is necessary at roof-to-wall intersections. Roof-to-wall/apron flashing should extend a minimum of 2" up vertical walls, and provide a minimum of 3" overlap/headlap onto tile. The apron flashing is required to be overlapped a minimum of 2" by sheet metal counter flashing or wall cladding.
4. Dimensions shown are minimums and are intended to be approximate to all for reasonable tolerances due to field conditions.
5. The bottom edge of the counter flashing height settings shall be set above the roof deck a minimum of 4" for flat tile, 5" for low profile and 6" for high profile tile.
6. All metal flashing shall be a minimum of (No. 26 galvanized sheet metal) not less than 0.019 inch corrosion resistant metal (G90). See Table A for additional options.
7. Solid wood blocking is required behind Z-metal counter flashing applications.

Drawing shown depicts the application of all tile profiles. Unless otherwise noted, it would apply to either concrete or clay tiles.

MC-11A

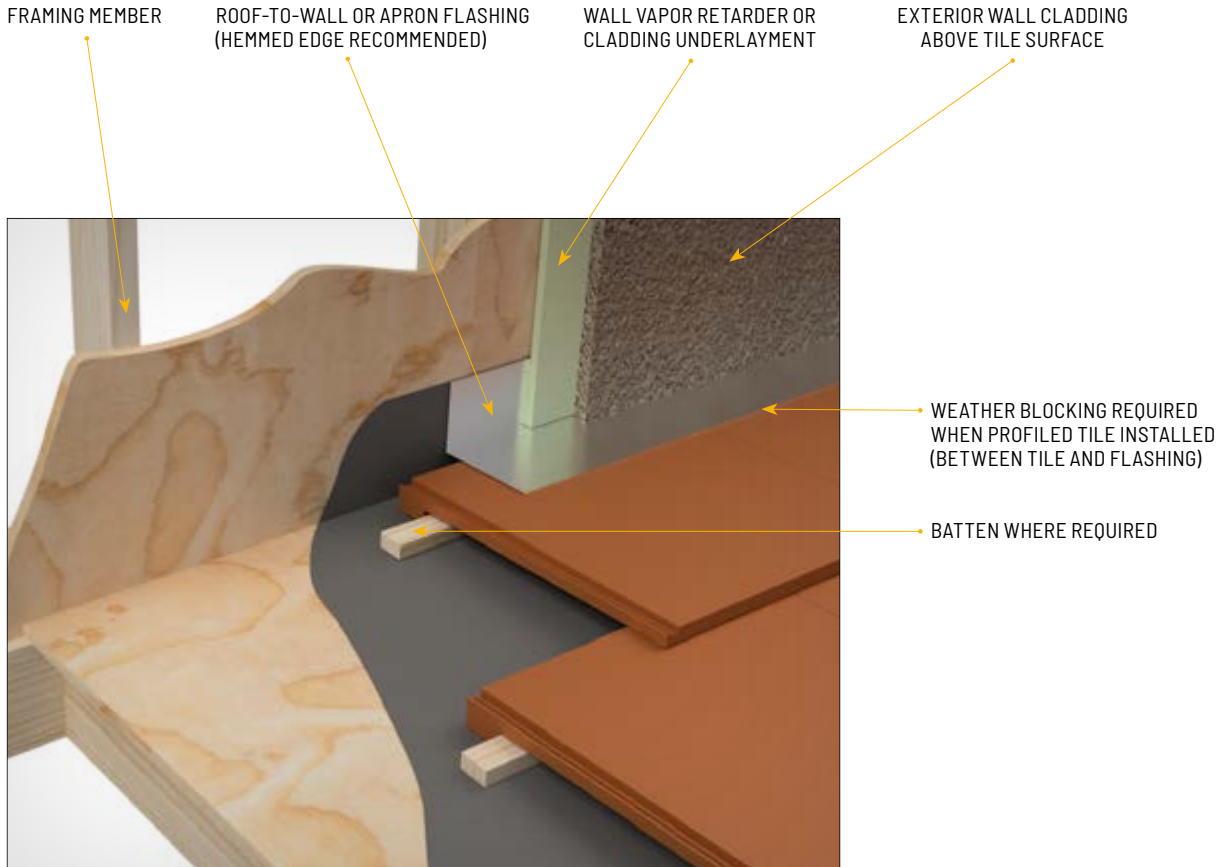
HEAD WALL FLASHING**Without Counter Flashing Z-Bar****NOTE:**

Openings at hips, ridges and head walls including chimneys, skylights, solar panels, and down slope horizontal abutments shall be fitted with weather blocking material to keep water on the surface of the field tile. Other methods approved by local building official will be allowed.

See TRI Alliance technical bulletin at www.tilerooting.org

NOTES:

1. For recommended underlayment and fastening, see Page 13, Table 1A, 1B & 1C.
2. Underlayment shall extend a minimum of 4" up vertical wood blocking or wall, and is suggested to extend above wall flashing.
3. Apron flashing or other roof-to-wall closure material is necessary at roof-to-wall intersections. Roof-to-wall/apron flashing should extend a minimum of 2" up vertical walls, and provide a minimum of 3" overlap/headlap onto tile. The apron flashing is required to be overlapped a minimum of 2" by sheet metal counter flashing or wall cladding.
4. Dimensions shown are minimums and are intended to be approximate to all for reasonable tolerances due to field conditions.
5. The bottom edge of the counter flashing height settings shall be set above the roof deck a minimum of 4" for flat tile, 5" for low profile and 6" for high profile tile.
6. All metal flashing shall be a minimum of (No. 26 galvanized sheet metal) not less than 0.019 inch corrosion resistant metal (G90). See Table A for additional options.

Drawing shown depicts the application of all tile profiles. Unless otherwise noted, it would apply to either concrete or clay tiles.

PAN FLASHING AT ROOF-TO-SIDEWALL

MC-12

Where Wall Extends Past Eave With Counter Flashing (Z-Bar)

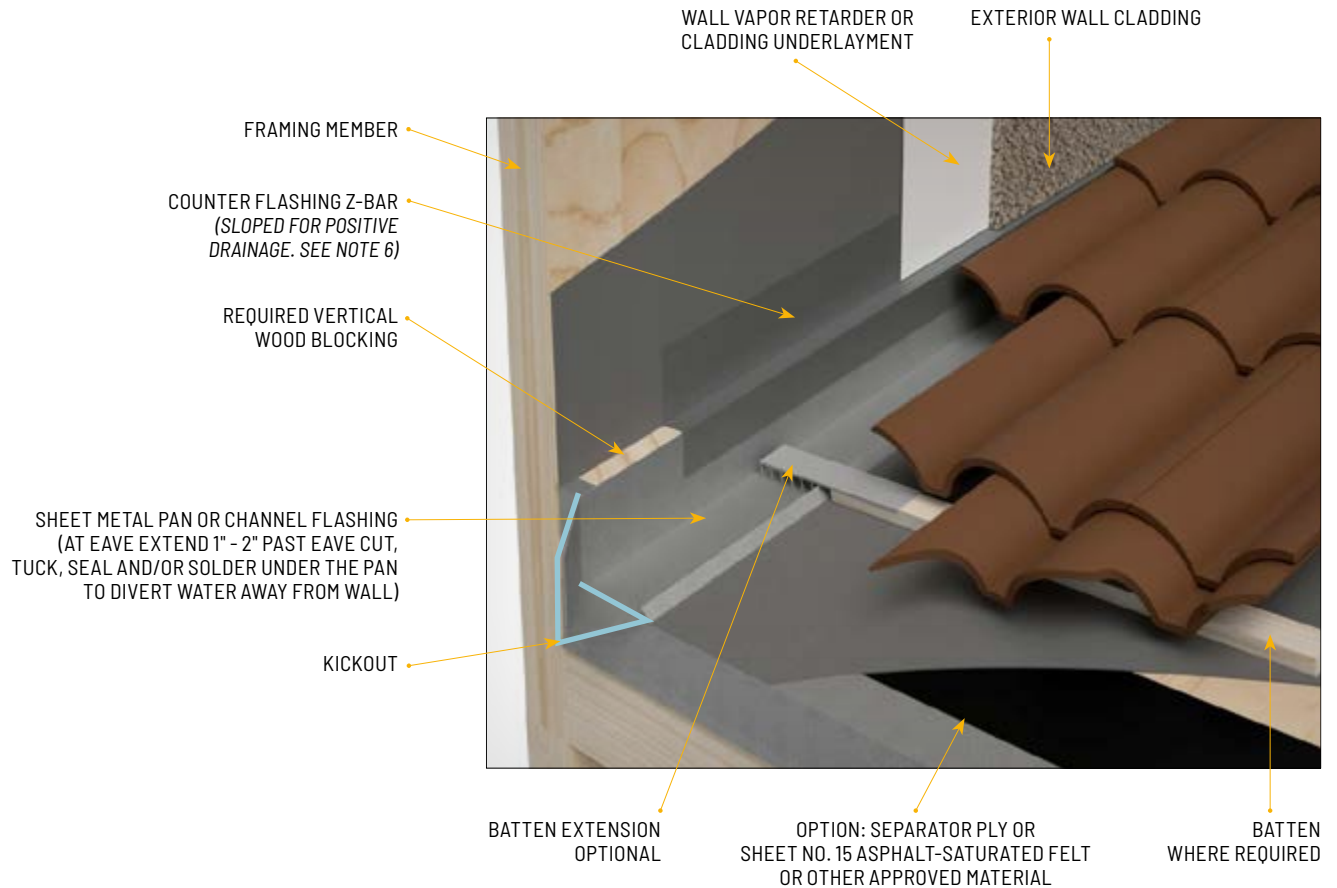

MINIMUM PAN FLASHING

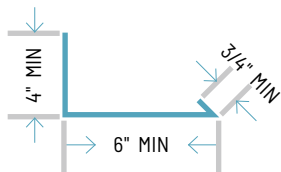

OPTIONAL PAN FLASHING

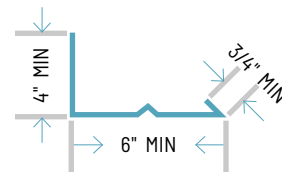

NOTES:

1. For recommended underlayment and fastening, see Page 13, Table 1A, 1B & 1C.
2. Underlayment shall extend a minimum of 4" up vertical wood blocking or wall.
3. Sheet metal pan flashing shall extend a minimum of 4" up the vertical wall approximately 6" out over the deck and have a minimum 3/4" return upward.
4. Solid wood blocking is required behind pan flashing and Z-metal counter flashing. Z metal or other counter flashing shall overlap vertical flange or pan or channel flashing by approximately 2" or greater.
5. At terminating tile, cut head lugs where they would otherwise create a damming condition or drainage impairment. Use a roof tile adhesive approved by the local building official or use wire ties or batten extender to secure tile.
6. Dimensions shown are minimums and are intended to be approximate to all for reasonable tolerances due to field conditions.
7. All metal flashing shall be a minimum of (No. 26 galvanized sheet metal) not less than 0.019 inch corrosion resistant metal (G90).
8. See Table A for additional options.

Drawing shown depicts the application of all tile profiles. Unless otherwise noted, it would apply to either concrete or clay tiles.

MC-12A

PAN FLASHING AT ROOF-TO-SIDEWALL

Where Wall Extends Past Eave

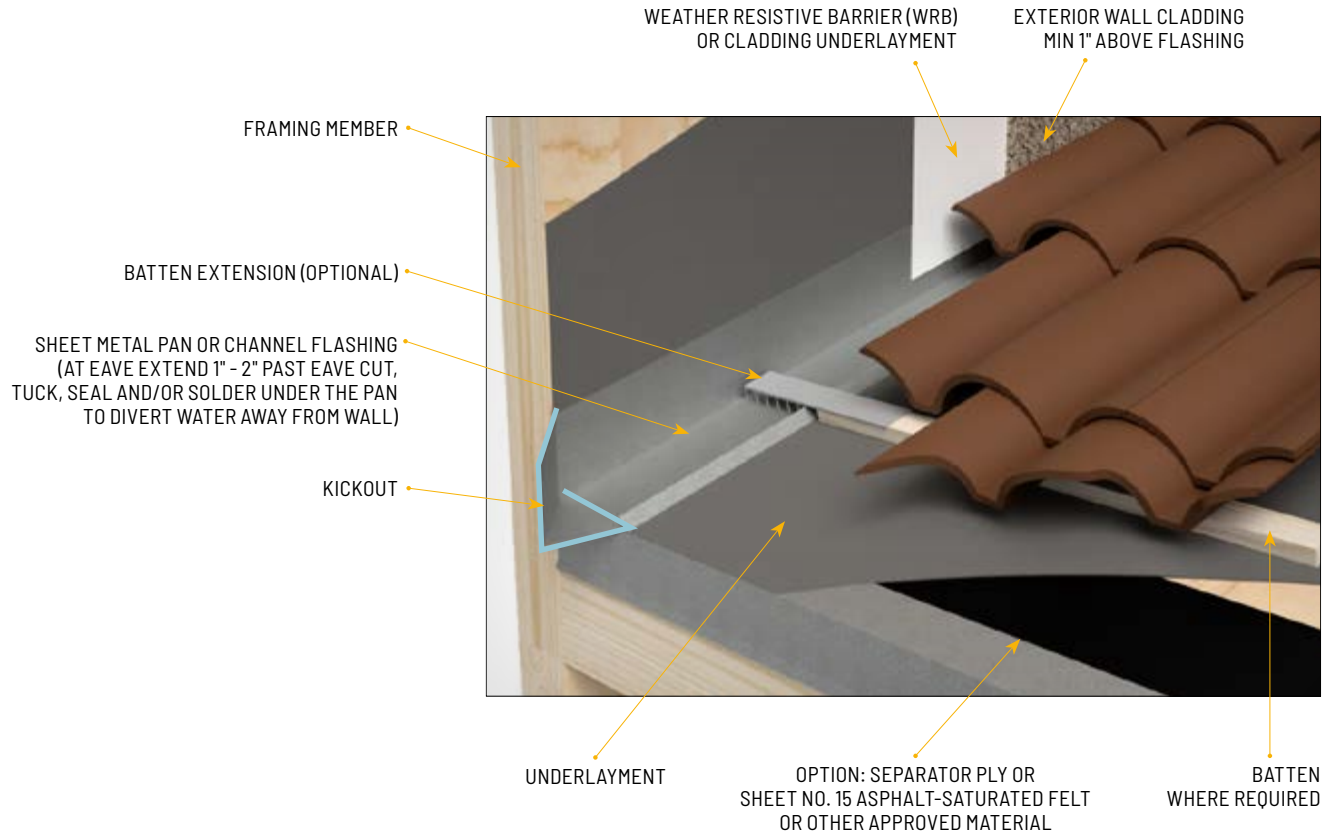

MINIMUM PAN FLASHING

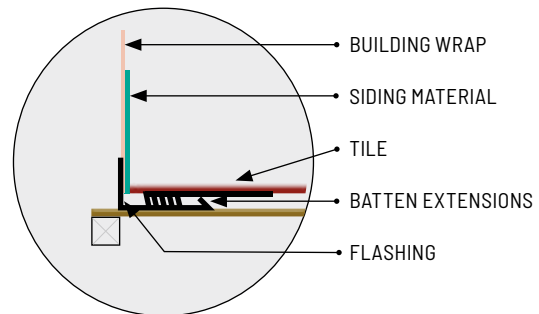
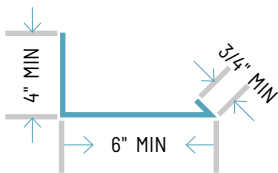
**NOTES:**

1. For recommended underlayment and fastening, see Page 13, Table 1A, 1B & 1C.
2. Underlayment shall extend a minimum of 4" up vertical wood blocking or wall.
3. Sheet metal pan flashing shall extend a minimum of 4" up the vertical wall approximately 6" out over the deck and have a minimum 3/4" return upward.
4. Solid wood blocking is required behind pan flashing and Z-metal counter flashing. Z metal or other counter flashing shall overlap vertical flange or pan or channel flashing by approximately 2" or greater.
5. At terminating tile, cut head lugs where they would otherwise create a damming condition or drainage impairment. Use a roof tile adhesive approved by the local building official or sue wire ties or batten extender to secure tile.
6. Dimensions shown are minimums and are intended to be approximate to all for reasonable tolerances due to field conditions.
7. All metal flashing shall be a minimum of (No. 26 galvanized sheet metal) not less than 0.019 inch corrosion resistant metal (G90).
8. See Table A for additional options.

Drawing shown depicts the application of all tile profiles. Unless otherwise noted, it would apply to either concrete or clay tiles.

METAL FLASHING EXAMPLES

MC-12B

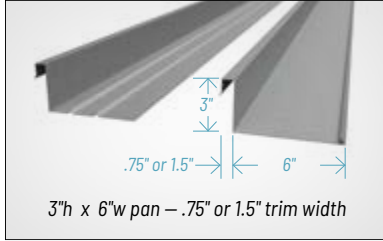

METAL RAKE FLASHING

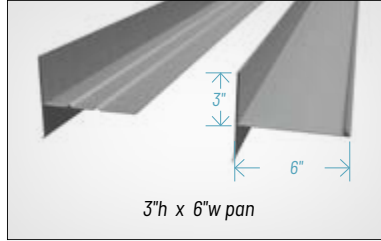

METAL RAKE TRIM

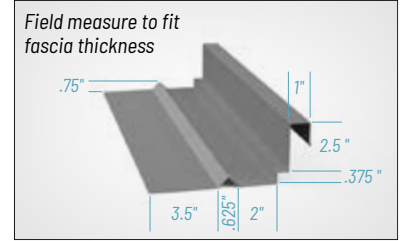

GABLE FLASHING

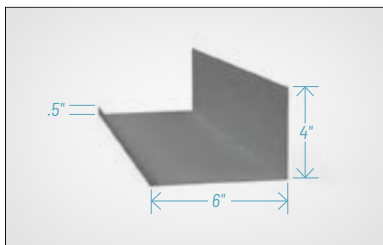

TILE PAN FLASHING

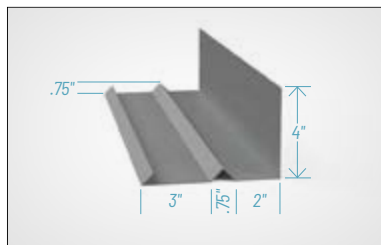

RIBBED TILE PAN FLASHING

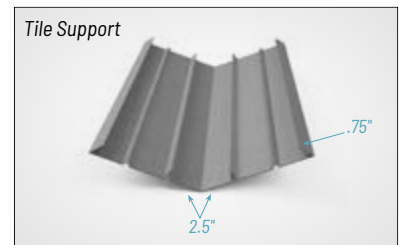

HIGH DOUBLE CROWN

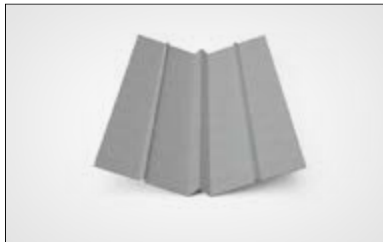

TRIPLE CROWN W/O CRIMPED EDGE

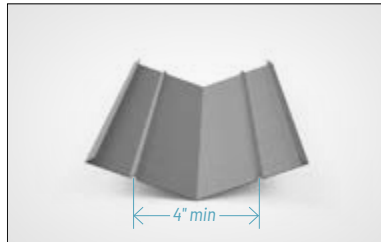

DOUBLE CROWN VALLEY



SINGLE CROWN VALLEY

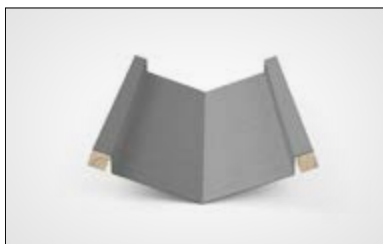

DEEP TROUGH VALLEY

NOTES:

1. These pictures show options that are found in the field at this time; other designs that will handle anticipated water flows may be used upon submissions of supporting data indicating anticipated water flows are equivalent to the code requirements as approved by local building official.
2. Valley metals shall extend 11" each way in compliance with International Building Code (IBC) section 1507.3.9, International Residential Code (IRC) R905.3.8 and the Uniform Building Code (UBC) section 1508.4 unless approved by the local building official.
3. Tile valleys may be cut open or closed.
4. When flat profile tile is installed "Closed Valley" a ribbed valley metal or single crown valley metal with a batten extension shall be used. Valley metals shall conform to IBC section 1507.3.9, IRC R905.3.8 and UBC section 1508.4
5. Dimensions shown are minimums and are intended to be approximate to all for reasonable tolerances due to field conditions.
6. All metal flashing shall be a minimum of (No. 26 galvanized sheet metal) not less than 0.019 inch corrosion resistant metal (G90).
7. See Table A for additional options.

Drawing shown depicts the application of all tile profiles. Unless otherwise noted, it would apply to either concrete or clay tiles.

MC-13

SIDE WALL DETAIL—CLAY "S" TILE

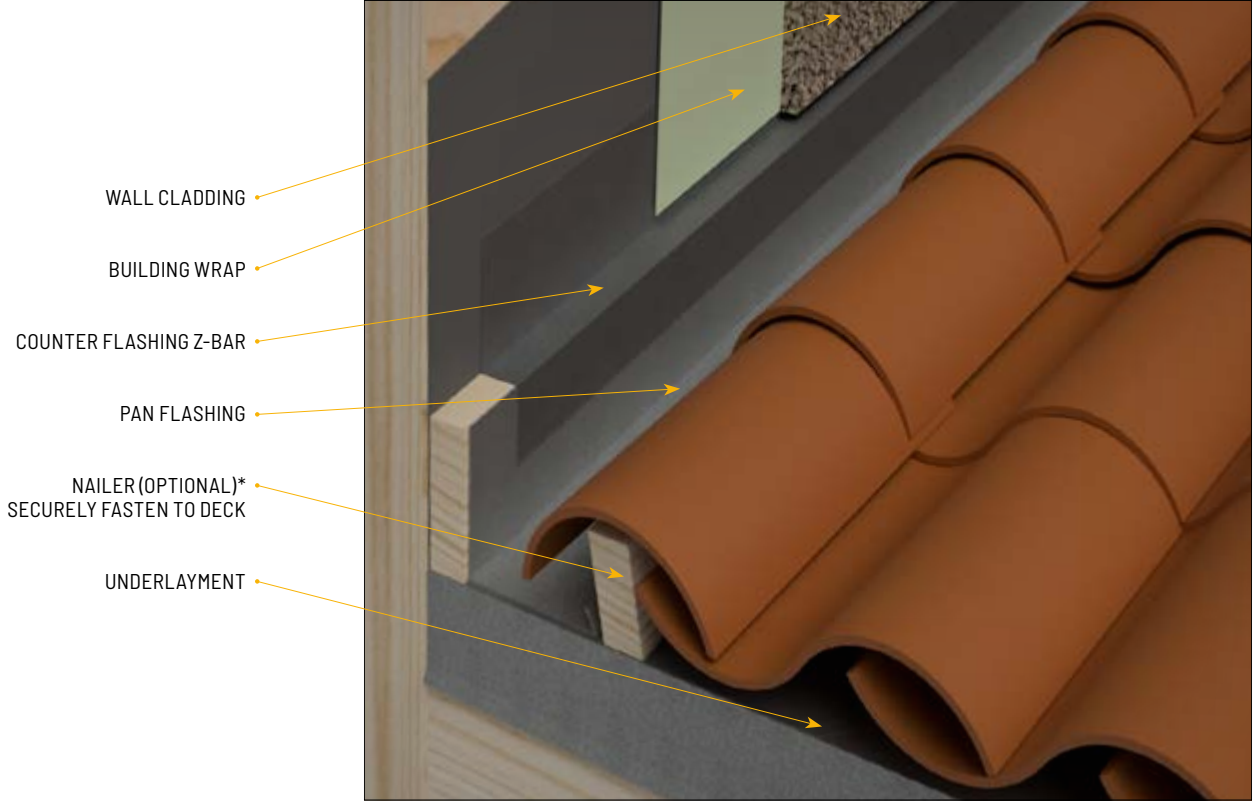

* NOTE: TILES TO BE INSTALLED IN SUCH A FASHION AS TO PREVENT WATER DIVERSION OR BLOCKAGE. FOR RECOMMENDED UNDERLAYMENT AND FASTENING REQUIREMENTS, SEE TABLE 1A AND TABLE 1B.

Appendix A

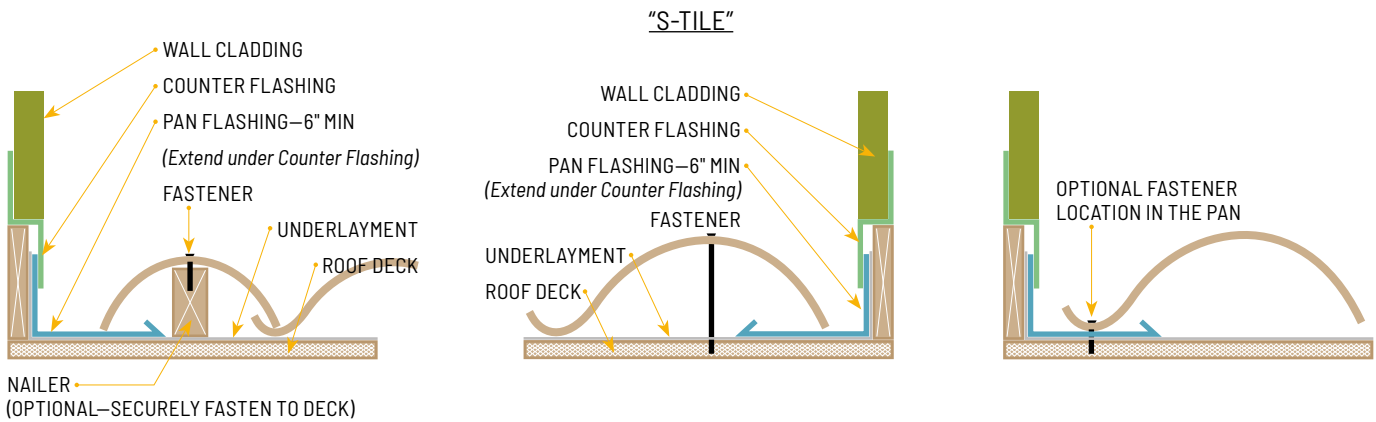

NOTES:

1. Underlayment should extend a minimum of 4" up vertical wood blocking or wall.
2. See MC-12B for additional flashing details.

Drawing shown depicts the application of all tile profiles. Unless otherwise noted, it would apply to either concrete or clay tiles.

SIDEWALL DETAILS—TWO PIECE CLAY

MC-13A

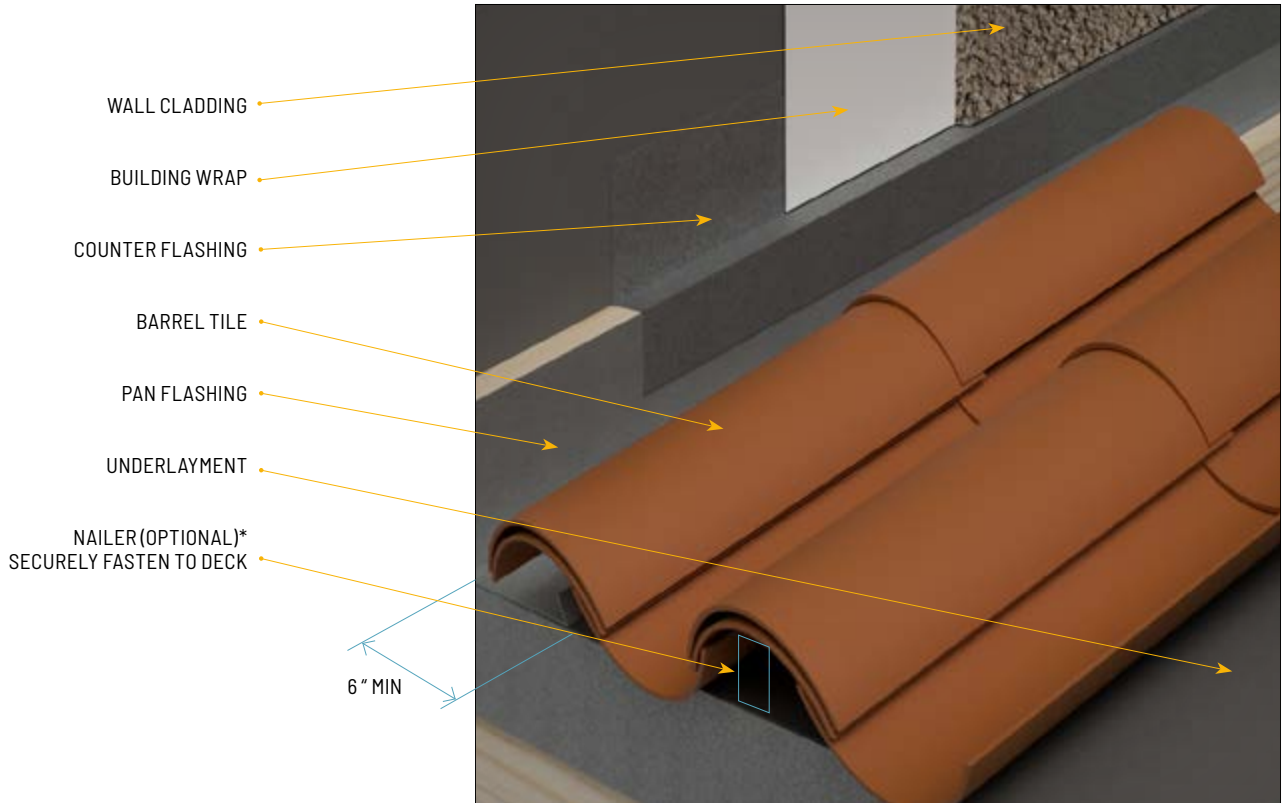

Appendix A

* NOTE: TILES TO BE INSTALLED IN SUCH A FASHION AS TO PREVENT WATER DIVERSION OR BLOCKAGE. FOR RECOMMENDED UNDERLAYMENT AND FASTENING REQUIREMENTS, SEE TABLE 1A, 1B AND 1C

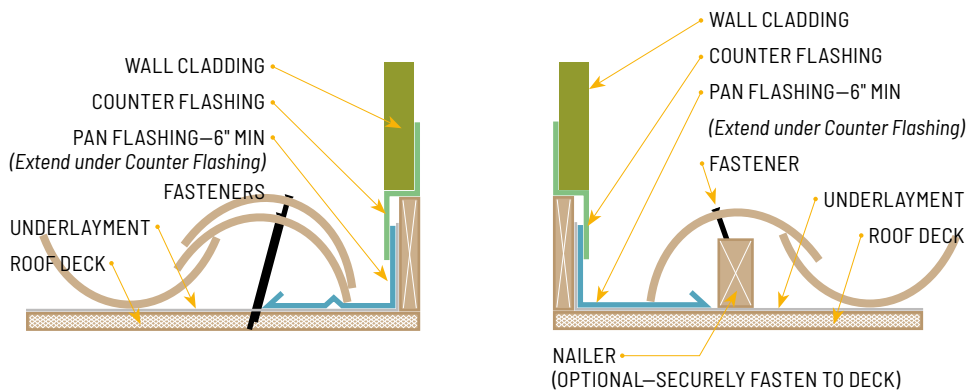

NOTES:

1. Underlayment should extend a minimum of 4" up vertical wood blocking or wall.
2. See MC-12B for additional flashing details.

Drawing shown depicts the application of all tile profiles. Unless otherwise noted, it would apply to either concrete or clay tiles.

MC-14

CHIMNEY FLASHING—PAN TYPE

Chimney Or Other Penetrations 30" Or Less In Width

NOTE: WHERE DEBRIS CAN ACCUMULATE, SEE STEP FLASHING OPTION "MC-14A"

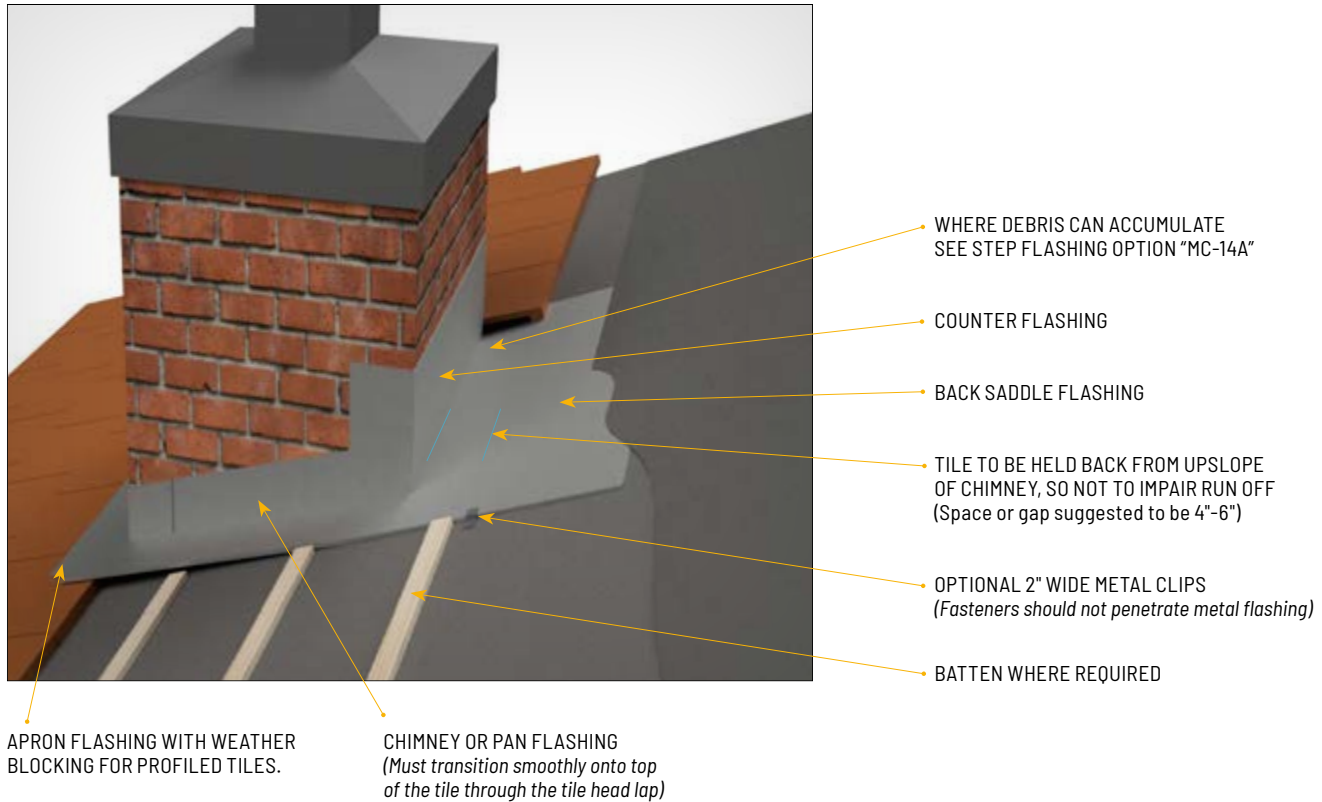

NOTE: Apron to be of sufficient length
to provide a min. 3" lap onto tile

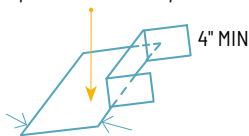

APRON FLASHING

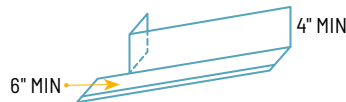

PAN OR CHANNEL FLASHING

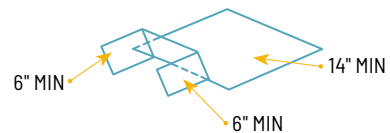

BACKER OR SADDLE FLASHING

NOTES:

1. Chimney flashing dimensions may vary according to local weather conditions, chimney size, chimney location, slope of roof, rafter length behind chimney and tributary water area.
2. A backer or saddle flashing may be used for chimneys and other penetrations 30" or less in width. Extend a minimum 6" up chimney.
3. A diverter or cricket flashing recommended for chimneys and other penetrations equal to or greater than 30" in width promote positive runoff.
4. Dimensions shown are minimums and are intended to be approximate to all for reasonable tolerances due to field conditions.
5. Flashing must be securely fastened to chimney or sidewall flashing.
6. Underlayment must turn up chimney wall a minimum of 4".
7. All chimney flashing shall be a minimum of (No. 26 galvanized sheet metal) not less than 0.019 inch corrosion resistant metal (G90).
8. See Table A for additional options.

Drawing shown depicts the application of all tile profiles. Unless otherwise noted, it would apply to either concrete or clay tiles.

PAN FLASHING AT ROOF-TO-SIDEWALL

MC-14A

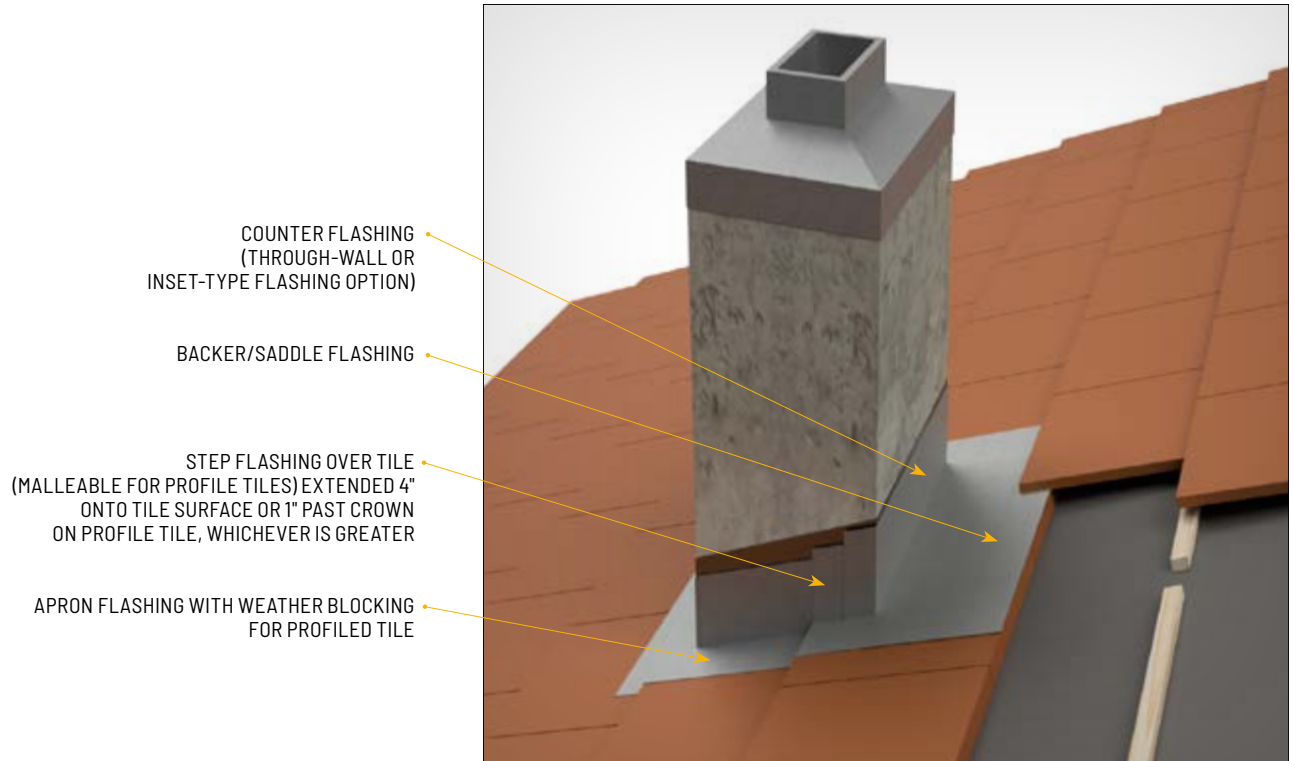

NOTE: Apron to be of sufficient length to provide a min. 3" lap onto tile

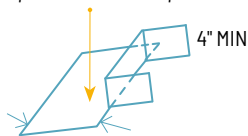

APRON FLASHING

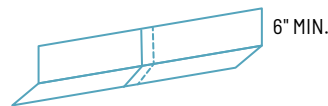

STEP FLASHING

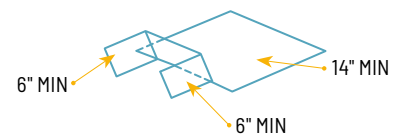

BACKER OR SADDLE FLASHING

NOTES:

1. Chimney flashing dimensions may vary according to local weather conditions, chimney size, chimney location, slope of roof, rafter length behind chimney and tributary water area.
2. A backer or saddle flashing may be used for chimneys and other penetrations 30" or less in width. Extend a minimum 6" up chimney.
3. A diverter or cricket flashing recommended for chimneys and other penetrations equal to or greater than 30" in width promote positive runoff.
4. Dimensions shown are minimums and are intended to be approximate to all for reasonable tolerances due to field conditions.
5. Flashing must be securely fastened to chimney or sidewall flashing.
6. Underlayment must turn up chimney wall a minimum of 4".
7. All chimney flashing shall be a minimum of (No. 26 galvanized sheet metal) not less than 0.019 inch corrosion resistant metal (G90).
8. See Table A for additional options.

Drawing shown depicts the application of all tile profiles. Unless otherwise noted, it would apply to either concrete or clay tiles.

MC-15

CHIMNEY FLASHING - PAN TYPE

Chimney Or Other Penetrations Greater Than 30" Wide

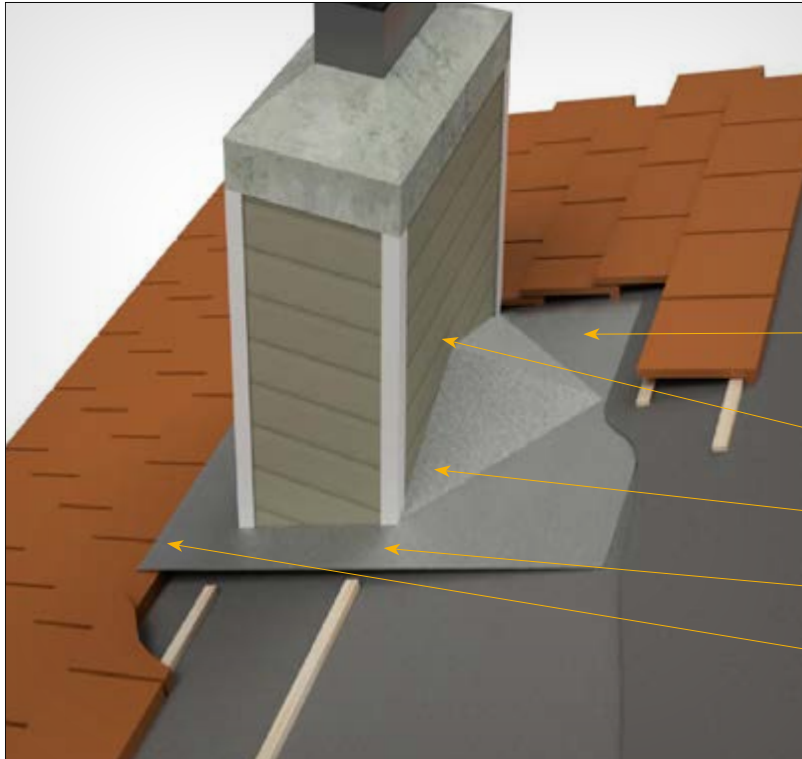

CRICKET MAY BE COVERED WITH AN APPROVED SEALED SYSTEM IN ACCORDANCE WITH LOW-SLOPE ROOFING REQUIREMENTS

CRICKET FLASHING (EXTEND UPPER END OF FLASHING 6" MIN. BEYOND FIRST COURSE OF OVERLAYING TILE)

MIN 2" ABOVE APEX

CRICKET METAL FLASHING WITH OPTIONAL HEM

CHANNEL OR PAN FLASHING

APRON FLASHING WITH WEATHER BLOCKING FOR PROFILED TILES

NOTE: Apron to be of sufficient length to provide a min. 3" lap onto tile

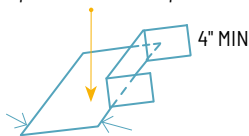

APRON FLASHING

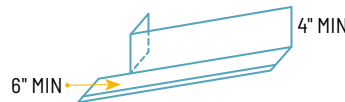

PAN OR CHANNEL FLASHING

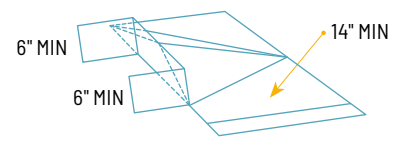

CRICKET FLASHING

NOTES:

1. Chimney flashing dimensions may vary according to local weather conditions, chimney size, chimney location, slope of roof, rafter length behind chimney and tributary water area.
2. A backer or saddle flashing may be used for chimneys and other penetrations 30" or less in width.
3. Extend a minimum 6" up chimney.
4. A diverter or cricket flashing recommended for chimneys and other penetrations greater than 30" in width promote positive runoff.
5. Dimensions shown are minimums and are intended to be approximate to all for reasonable tolerances due to field conditions.
6. Underlayment must turn up chimney wall a minimum of 4".
7. All chimney flashing shall be a minimum of (No. 26 galvanized sheet metal) not less than 0.019 inch corrosion resistant metal (G90).
8. See Table A for additional options.

Drawing shown depicts the application of all tile profiles. Unless otherwise noted, it would apply to either concrete or clay tiles.

CHIMNEY FLASHING - STEP TYPE

MC-15A

Chimney Or Other Penetrations Greater Than 30" Wide

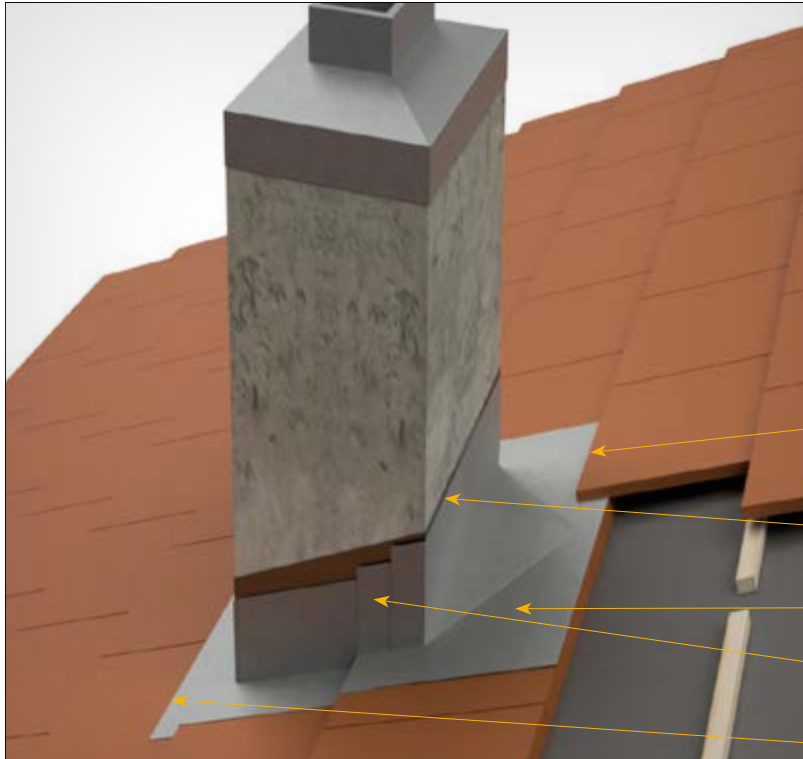

CRICKET FLASHING (EXTEND UPPER END OF FLASHING 6" MIN. BEYOND FIRST COURSE OF OVERLAYING TILE)

COUNTER FLASHING

CRICKET METAL FLASHING WITH OPTIONAL HEM

STEP FLASHING OVER TILE

APRON FLASHING

NOTE: Apron to be of sufficient length to provide a min. 3" lap onto tile

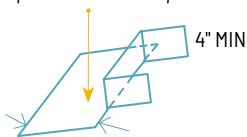

APRON FLASHING

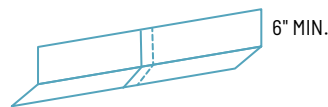

STEP FLASHING

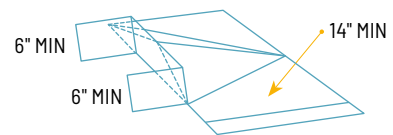

CRICKET FLASHING

NOTES:

1. Chimney flashing dimensions may vary according to local weather conditions, chimney size, chimney location, slope of roof, rafter length behind chimney and tributary water area.
2. A backer or saddle flashing may be used for chimneys and other penetrations 30" or less in width.
3. Extend a minimum 6" up chimney.
4. A diverter or cricket flashing recommended for chimneys and other penetrations greater than 30" in width promote positive runoff.
5. Dimensions shown are minimums and are intended to be approximate to all for reasonable tolerances due to field conditions.
6. Underlayment must turn up chimney wall a minimum of 4"
7. All chimney flashing shall be a minimum of (No. 26 galvanized sheet metal) not less than 0.019 inch corrosion resistant metal (G).
8. See Table A for additional options.

Drawing shown depicts the application of all tile profiles. Unless otherwise noted, it would apply to either concrete or clay tiles.

MC-16

SKYLIGHT UNDERLAYMENT DETAIL

Typical Curb Skylight Opening

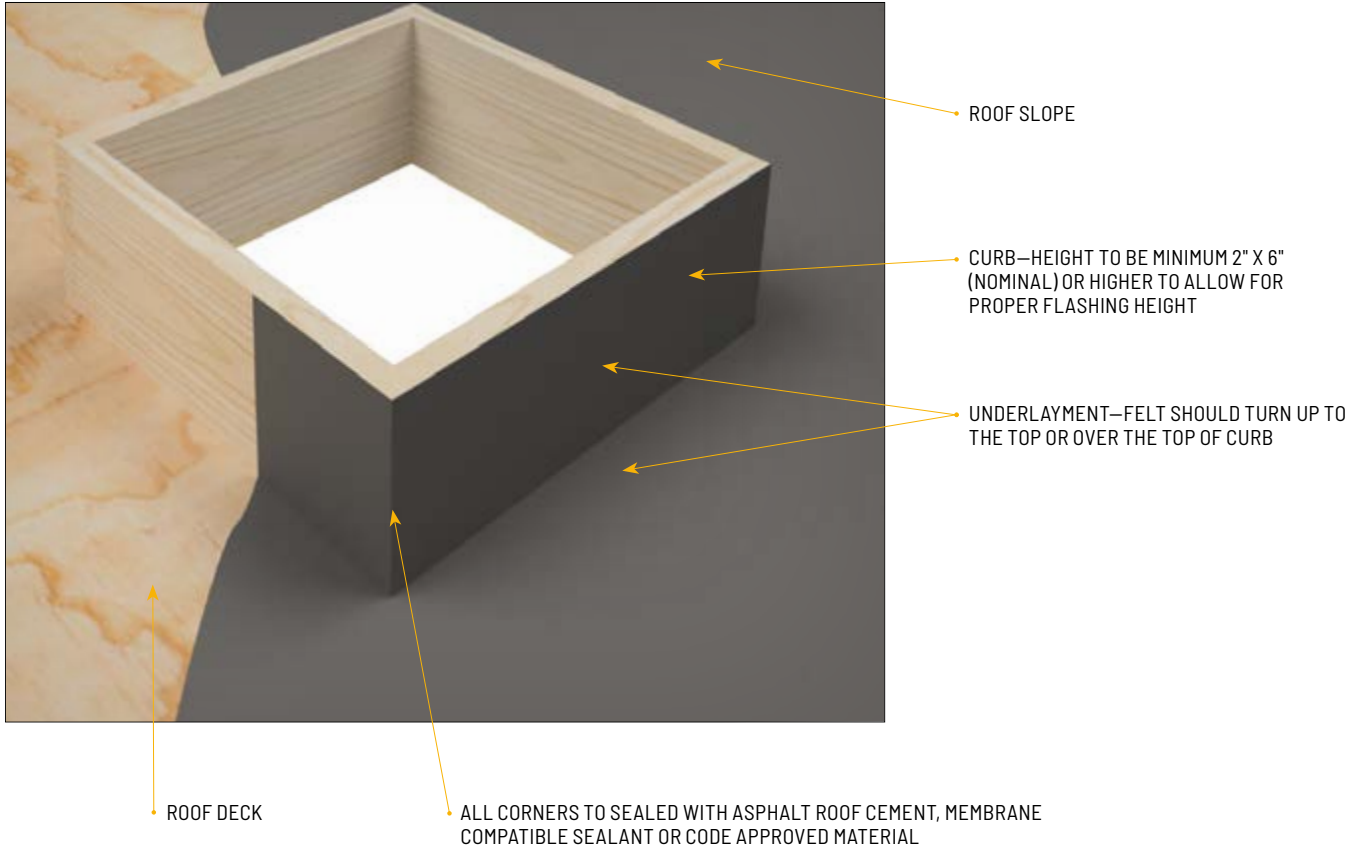
**NOTES:**

1. For recommended underlayment and flashing requirements, see page 13 TABLE 1A, 1B and 1C.
2. Dimensions shown are minimums and are intended to be approximate to all for reasonable tolerances due to field conditions.
3. A backer or saddle flashing may be used for curbed penetrations, depending upon width or curb.
4. Extend flashings a minimum of 6" up curb.

Drawing shown depicts the application of all tile profiles. Unless otherwise noted, it would apply to either concrete or clay tiles.

SKYLIGHT FLASHING—PAN TYPE

MC-16A

Typical Curb Skylight Opening

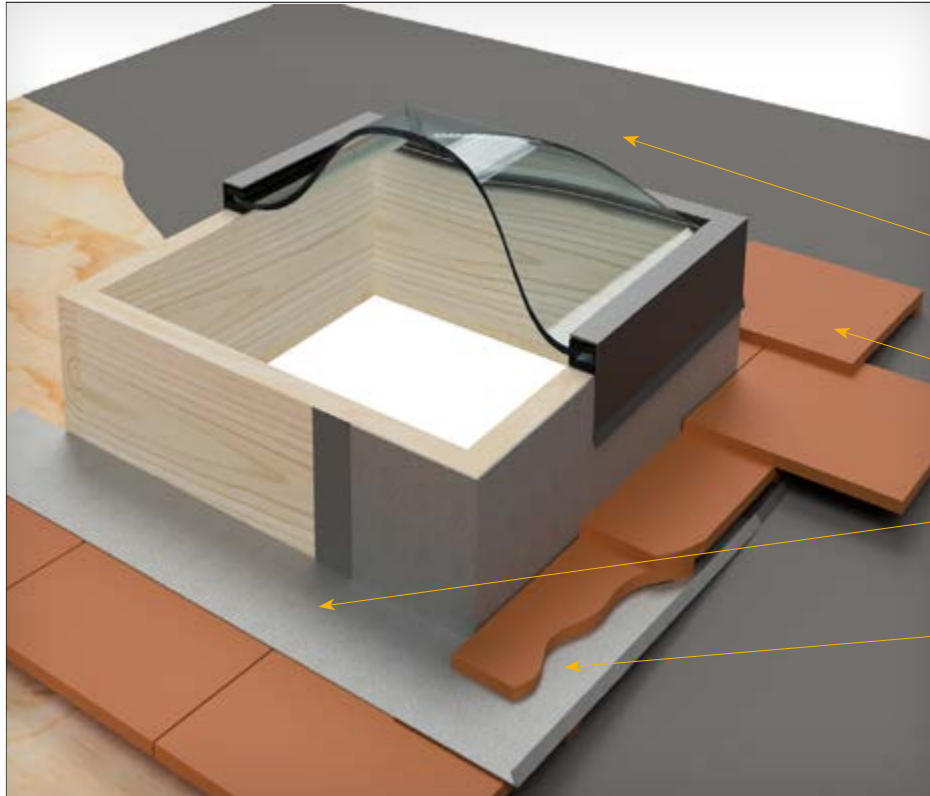

NOTE: WHERE DEBRIS CAN ACCUMULATE, SEE STEP FLASHING OPTIONS "MC-16B"

SADDLE OR CRICKET FLASHING BIBBED OR SEALED WITH THREE COURSE APPLICATION

TILE TO BE HELD BACK FROM UPSLOPE CURB OF SKYLIGHT, SO NOT TO IMPAIR RUN OFF

APRON FLASHING OF SUFFICIENT LENGTH TO PROVIDE 3" MIN. LAP ONTO TILE

PAN OR CHANNEL FLASHING

BATTENS WHERE REQUIRED



APRON FLASHING

PAN OR CHANNEL FLASHING

SADDLE/BACKER FLASHING

NOTES:

1. Skylight flashing dimensions may vary according to local weather conditions, skylight size, location, slope of roof, rafter length behind skylight and tributary water area.
2. A backer or saddle flashing may be used for skylights and other penetrations 30" or less in width.
3. Extend a minimum 6" up chimney.
4. A diverter or cricket flashing recommended for skylights and other penetrations greater than 30" in width promote positive runoff.
5. Dimensions shown are minimums and are intended to be approximate to all for reasonable tolerances due to field conditions.
6. Underlayment must turn up chimney wall a minimum of 4"
7. All skylight flashing shall be a minimum of (No. 26 galvanized sheet metal) not less than 0.019 inch corrosion resistant metal (G90).
8. See Table A for additional options.

Drawing shown depicts the application of all tile profiles. Unless otherwise noted, it would apply to either concrete or clay tiles.

MC-16B

SKYLIGHT FLASHING—STEP TYPE

Typical Curb Skylight Opening

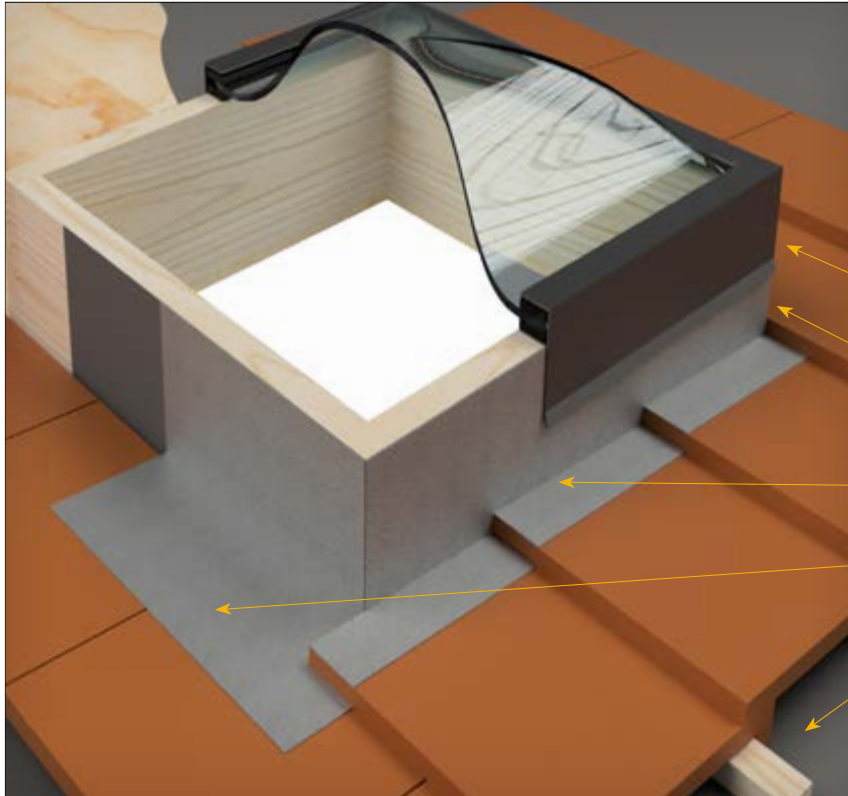

CURB HEIGHT TO BE A MINIMUM
2"X8" (NOMINAL) OR HIGHER TO
ALLOW FOR STEP FLASHINGS

SADDLE OR CRICKET FLASHING

TILE TO BE HELD BACK FROM UP SLOPE CURB OF
SKYLIGHT, SO AS NOT TO IMPAIR RUN OFF

STEP FLASHING (MALLEABLE FOR PROFILE TILE)

APRON FLASHING

UNDERLAYMENT

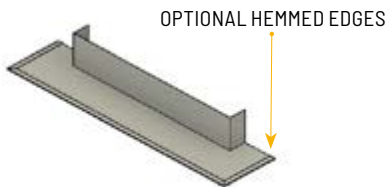

APRON FLASHING



PAN OR CHANNEL FLASHING

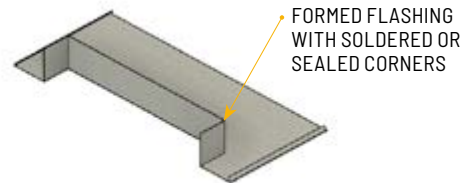

SADDLE/BACKER FLASHING

NOTES:

1. Skylight flashing dimensions may vary according to local weather conditions, skylight size, location, slope of roof, rafter length behind skylight and tributary water area.
2. A backer or saddle flashing may be used for skylights and other penetrations 30" or less in width.
3. Extend a minimum 6" up chimney.
4. A diverter or cricket flashing recommended for skylights and other penetrations greater than 30" in width promote positive runoff.
5. Dimensions shown are minimums and are intended to be approximate to all for reasonable tolerances due to field conditions.
6. Underlayment must turn up chimney wall a minimum of 4"
7. All skylight flashing shall be a minimum of (No. 26 galvanized sheet metal) not less than 0.019 inch corrosion resistant metal (G90).
8. See Table A for additional options.

Drawing shown depicts the application of all tile profiles. Unless otherwise noted, it would apply to either concrete or clay tiles.

OPEN VALLEY

MC-17

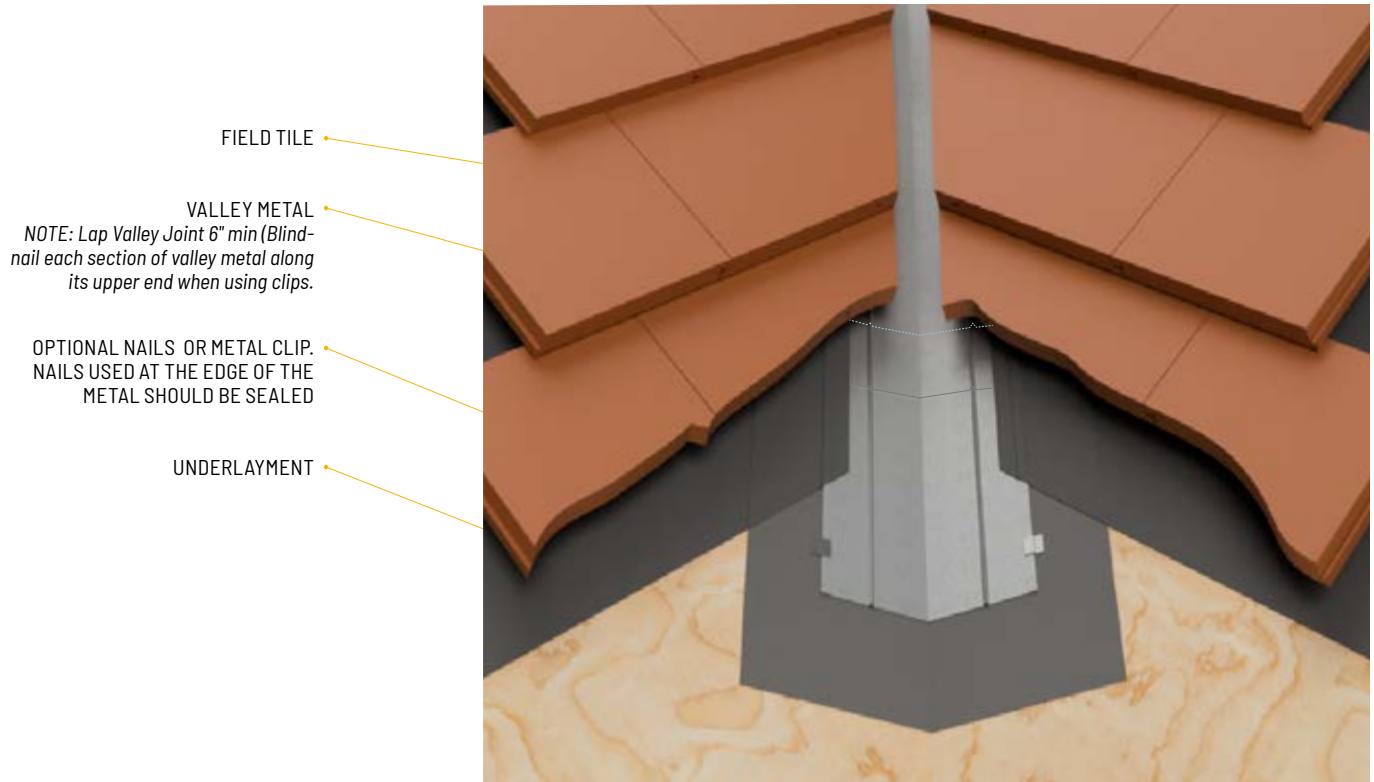
Tile Installed With Gap At Center Of Valley

NOTE: Tile at valley may be cut to form closed or open metal valley detail. When flat profiled tile is installed as "closed valley" a ribbed metal or single crown valley metal with a batten extension shall be used. When using standing hem flashing, use woven underlayment method. See MC-03 and MC-17B

NOTES:

1. For recommended underlayment and fastening, see Page 13, Table 1A, 1B & 1C
2. Cut tile pieces should be secured by one or a combination of the following: (a) code approved adhesive; (b) wire ties; (c) batten extensions; (d) cut tile clip or (e) other code approved fastening devices.
3. Metal valley flashing shall be a minimum of (No. 26 galvanized sheet metal) not less than 0.019 inch corrosion resistant metal (G90). See Table A for additional options.
4. Other valley metal profiles are available. See MC-12B for examples.
5. The tile must extend a minimum of 4" over the valley metal.
6. Dimensions shown are minimums and are intended to be approximate to all for reasonable tolerances due to field conditions.
7. Valley metals should be designed to suit climate area, control water runoff, and discharge expected water flows.

Drawing shown depicts the application of all tile profiles. Unless otherwise noted, it would apply to either concrete or clay tiles.

MC-17A

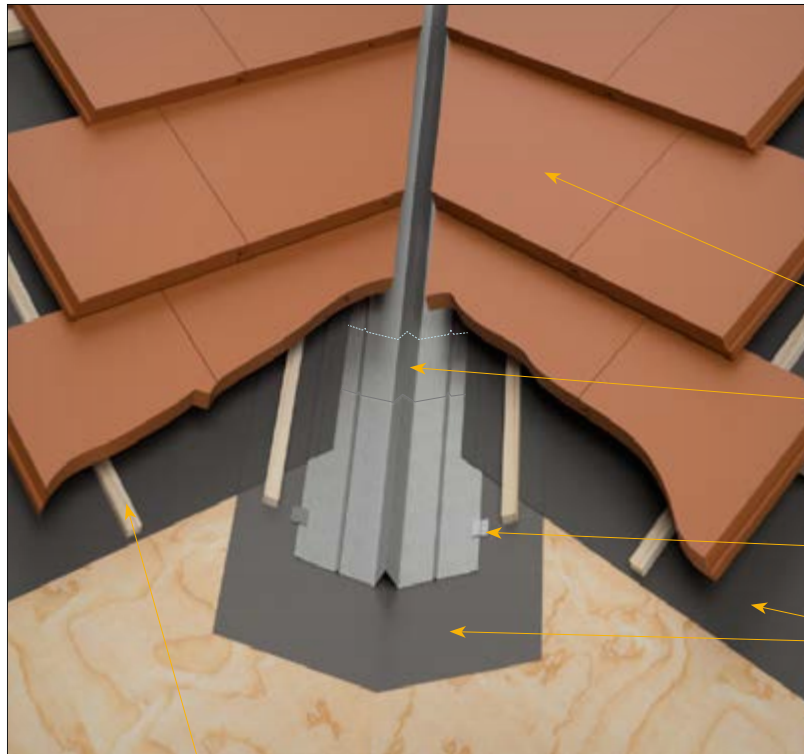
THREE RIB VALLEY METAL PROFILES**On Counter Batten Installations**

FIELD TILE

VALLEY METAL

NOTE: Lap Valley Joint 6" min (Blind-nail each section of valley metal along its upper end when using clips.)

OPTIONAL NAILS OR METAL CLIP. NAILS USED AT THE EDGE OF THE METAL SHOULD BE SEALED

UNDERLAYMENT

OPTIONAL HORIZONTAL BATTENS (REQUIRED IF VERTICAL BATTENS USED). NOT SHOWN

OPTIONAL VERTICAL BATTENS INSTALLED UNDER HORIZONTAL BATTENS

Notes:

1. For recommended underlayment and fastening, see Page 13, Table 1A, 1B & 1C
2. Cut tile pieces should be secured by one or a combination of the following: (a) code approved adhesive; (b) wire ties; (c) batten extensions; (d) cut tile clip or (e) other code approved fastening devices.
3. Metal valley flashing shall be a minimum of (No. 26 galvanized sheet metal) not less than 0.019 inch corrosion resistant metal (G90). See Table A for additional options.
4. Other valley metal profiles are available. See MC-12B for examples.
5. The tile must extend a minimum of 4" over the valley metal.
6. Dimensions shown are minimums and are intended to be approximate to all for reasonable tolerances due to field conditions.
7. Valley metals should be designed to suit climate area, control water runoff, and discharge expected water flows.

Drawing shown depicts the application of all tile profiles. Unless otherwise noted, it would apply to either concrete or clay tiles.

VALLEY METAL—FOR DEEP TROUGH VALLEY

MC-17B

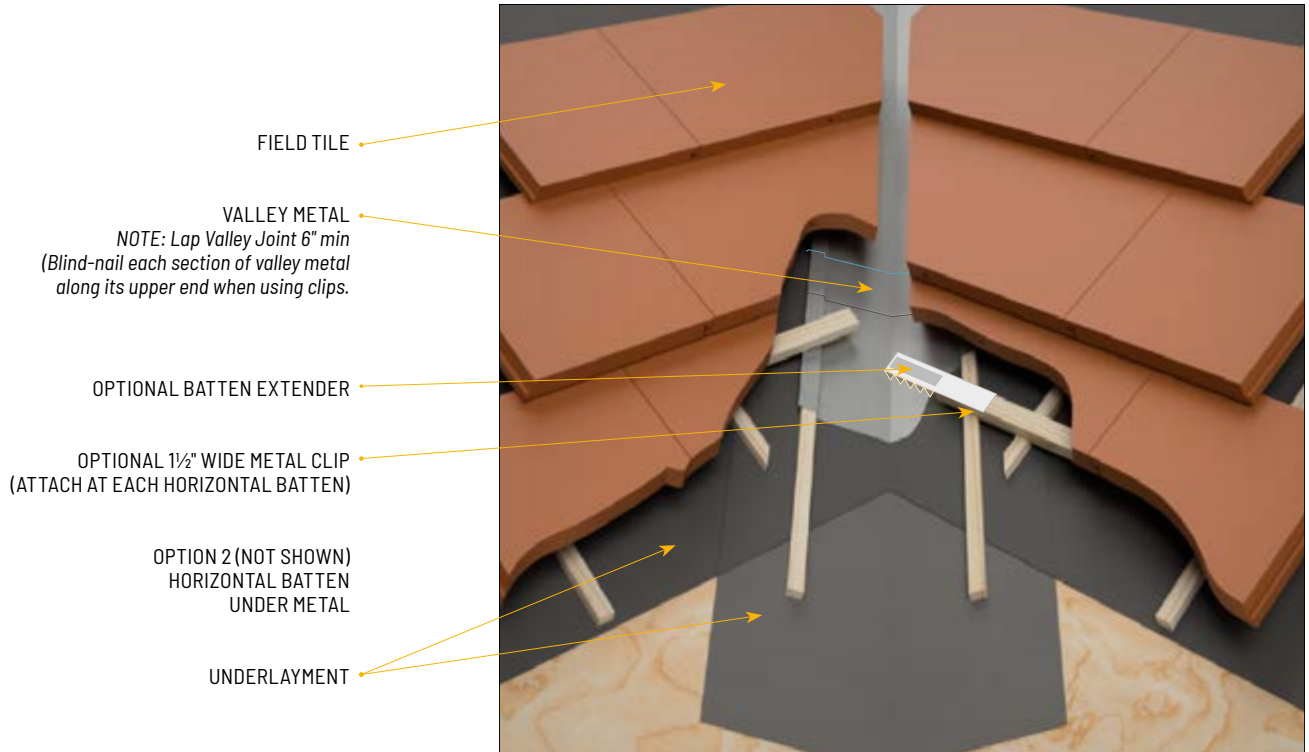

NOTE: VALLEY METAL SHALL EXTEND AT LEAST 11" FROM CENTER LINE EACH WAY AND SHALL HAVE A SPLASH DIVERTER RIB OF NOT LESS THAN 1" HIGH AT THE FLOW LINE FORMED AS PART OF THE FLASHING. OTHER DESIGNS THAT WILL HANDLE

ANTICIPATED WATER FLOWS MAY BE USED UPON SUBMISSION OF SUPPORTING DATA INDICATING THAT ANTICIPATED WATER FLOWS ARE EQUIVALENT TO THE CODE REQUIREMENTS.

Notes:

- For recommended underlayment and fastening, see Page 13, Table 1A, 1B & 1C
- Cut tile pieces should be secured by one or a combination of the following: (a) code approved adhesive; (b) wire ties; (c) batten extensions; (d) cut tile clip or (e) other code approved fastening devices.
- Metal valley flashing shall be a minimum of (No. 26 galvanized sheet metal) not less than 0.019 inch corrosion resistant metal (G90). See Table A for additional options.
- Valley flashings shall extend at least 11" from centerline each way and have a splash diverter rib not less than 1" high at flow line formed as part of the flashing. On projects with large expansive roof areas/or long rafter lengths, wider metal is required. Tile shall extend of the valley into valley trough a minimum of 1½"
- Other valley metal profiles are available. See MC-12B for examples.
- The tile must extend a minimum of 4" over the valley metal.
- Dimensions shown are minimums and are intended to be approximate to all for reasonable tolerances due to field conditions.
- Valley metals should be designed to suit climate area, control water runoff, and discharge expected water flows.

Drawing shown depicts the application of all tile profiles. Unless otherwise noted, it would apply to either concrete or clay tiles.

MC-17C

VALLEY TRANSITIONS

EXAMPLE OF FLAT OR
LOW PROFILE TILE

THE VALLEY METAL MUST LAP ONTO
THE TILE OF THE COURSE BELOW THE
ROOF TRANSITION FLASHING



EXAMPLE FOR HIGH PROFILE TILE

THE VALLEY METAL MUST LAP ONTO
THE TILE OF THE COURSE BELOW THE
ROOF TRANSITION FLASHING

LEAD SOAKER OR OTHER MALLEABLE MATERIAL
SHOULD BE USED TO FORM A WATER FLOW
TRANSITION FLASHING

Drawing shown depicts the application of all tile profiles. Unless otherwise noted, it would apply to either concrete or clay tiles.

BOXED-IN SOFFIT

MC-17D



Appendix A

SURFACE MOUNT FLASHING

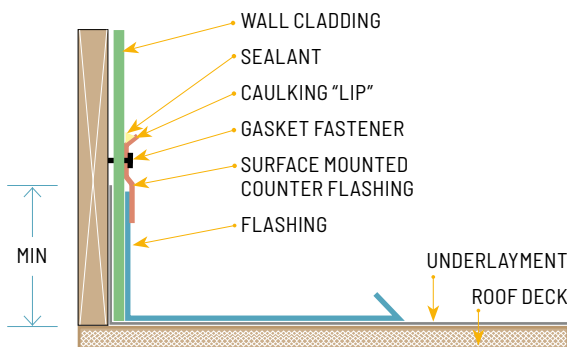

STEP FLASHING

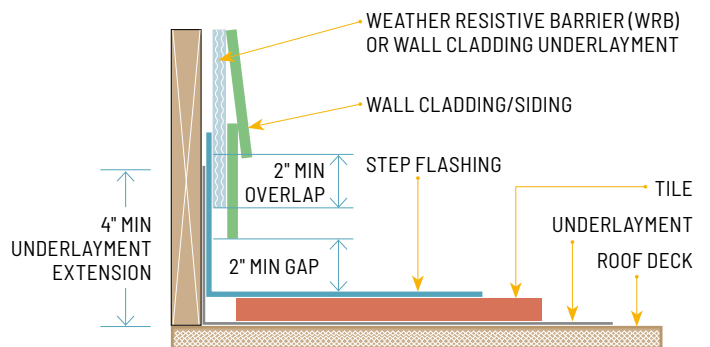

NOTES:

1. Surface-mounted flashing may be sufficient in some mild climates. However concealed or insert flashing such as "Z" metal or stucco-type two piece reglet and counter flashing or step flashing, are recommended in wet climates, particularly with stucco or other permeable cladding systems.
2. Dimensions shown are minimums and are intended to be approximate to all for reasonable tolerances due to field conditions.

Drawing shown depicts the application of all tile profiles. Unless otherwise noted, it would apply to either concrete or clay tiles.

MC-18

HIP AND RIDGE (OPTIONAL METHOD)

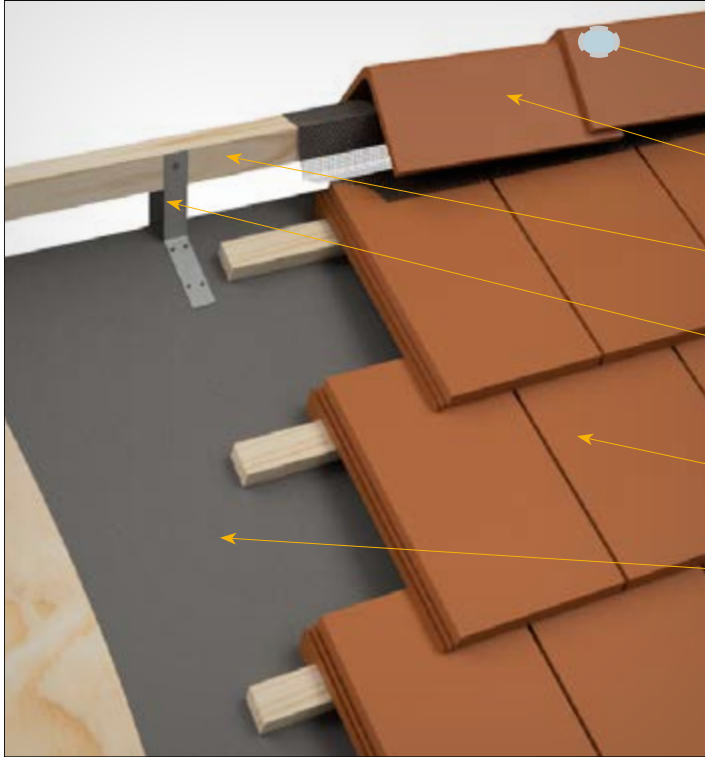

- CODE APPROVED ADHESIVE OVER MECHANICAL ATTACHMENT (SEE BELOW)
- TRIM TILES
- RIDGE/HIP NAILER OF SUFFICIENT HEIGHT TO MAINTAIN AN EVEN PLANE OF UNDERLAYMENT
- RIDGE RISER; HEAVY GAUGE GALVANIZED STEEL OR OTHER METAL, SECURELY FASTENED PER BRACKET MANUFACTURER INSTRUCTIONS.
- FIELD TILES
- UNDERLAYMENT

NOTE: Overhangs at hips, ridges and headwalls including chimneys, skylights, solar panels, and downslope horizontal abutments shall be fitted with weather blocking material to keep water on the surface of the field tile. Other materials approved by the local building official will be allowed. Wrapping of nailer board is optional except with the use of mortar. (All tile profiles)

Appendix A

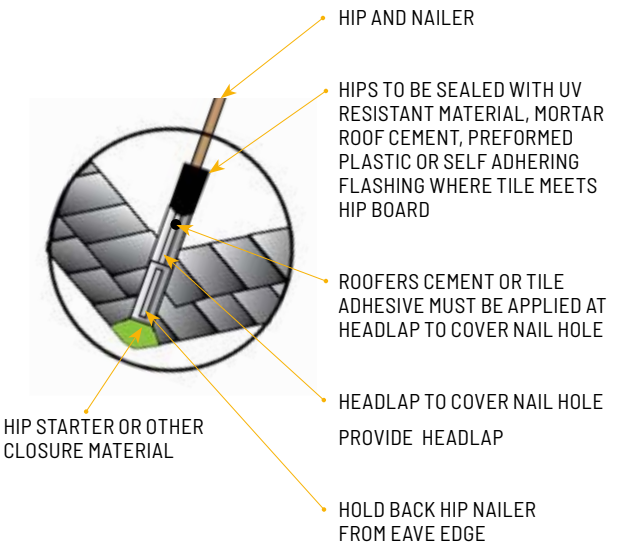
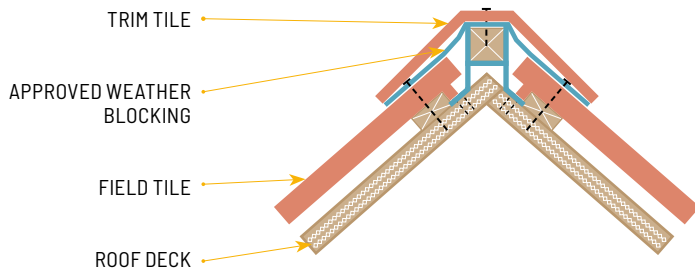

Notes:

1. For recommended underlayment and fastening, see Page 13, Table 1A, 1B & 1C.
2. All hip and ridge tile are required to have code approved adhesive between laps of trim tile to cover nail hole and create a bond between trim tiles.
3. Tile to be cut in a manner to properly conform to method of weather blocking material used.
4. Battens for tiles with protruding anchor lugs are optional for slopes between 3:12 and 7:12. Direct deck attachment of tile as approved by local building official.
5. Dimensions shown are minimums and are intended to be at proximate to all for reasonable tolerances due to field conditions.
6. Orientation and termination of ridge tiles may vary.

Drawing shown depicts the application of all tile profiles. Unless otherwise noted, it would apply to either concrete or clay tiles.

HIP AND RIDGE

MC-18A

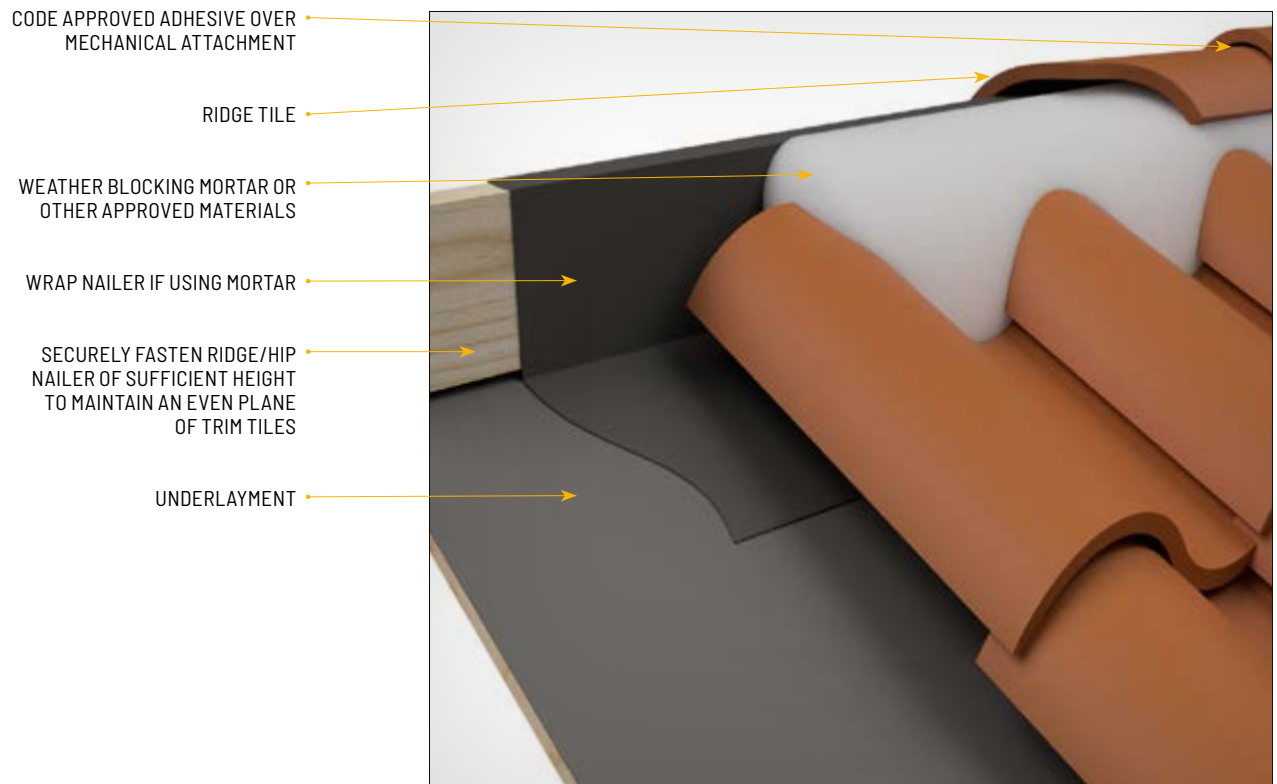

NOTE: Openings at hips, ridges and head walls including chimneys, skylights, solar panels, and down slope horizontal abutments shall be fitted with weather blocking material to keep water on the surface of the field tile. Other methods approved by local building official will be allowed. See TRI Alliance technical bulletin at www.tilerooting.org Wrapping of nailer board is required with the use of mortar (All profiles).

Notes:

1. For recommended underlayment and fastening, see Page 13, Table 1A, 1B & 1C.
2. All hip and ridge tile are required to have code approved adhesive between laps of trim tile to cover nail hole and create a bond between trim tiles.
3. Tile to be cut in a manner to properly conform to method of weather blocking material used.
4. Battens for tiles with protruding anchor lugs are optional for slopes between 3:12 and 7:12. Direct deck attachment of tile as approved by local building official.
5. Dimensions shown are minimums and are intended to be approximate to all for reasonable tolerances due to field conditions.

Drawing shown depicts the application of all tile profiles. Unless otherwise noted, it would apply to either concrete or clay tiles.

MC-18B

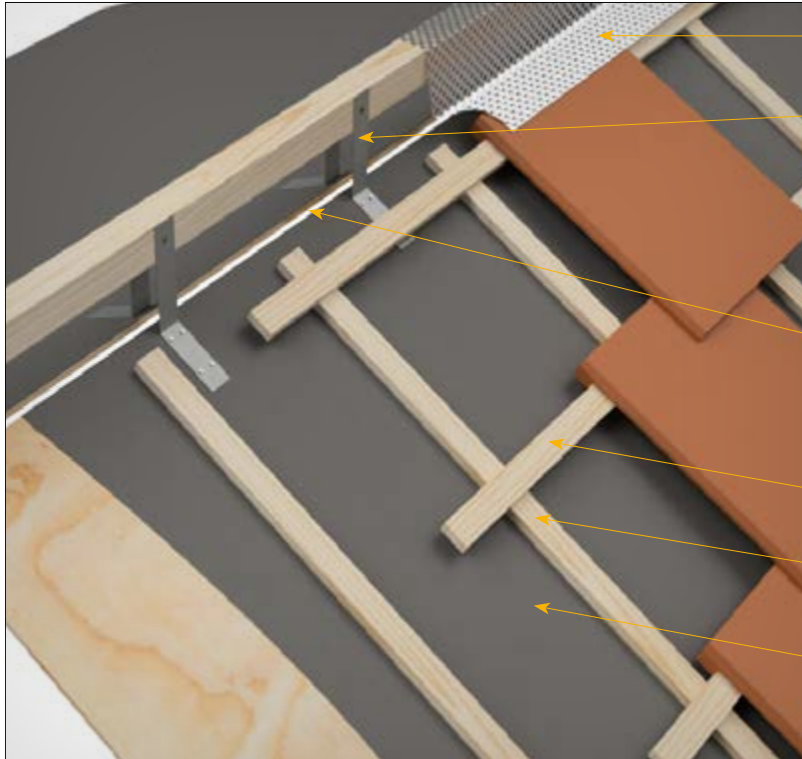
VENTED RIDGE (OPTIONAL METHOD)

VENTILATION MATERIAL

RIDGE RISER BRACKET:
HEAVY GALVANIZED STEEL, OR OTHER
METAL SECURELY FASTEN PER BRACKET
MANUFACTURER INSTRUCTIONS

RIDGE/HIP NAILER OF SUFFICIENT
HEIGHT TO MAINTAIN AN EVEN PLANE
OF TRIM TILES

CONTINUOUS 1" WIDE VENTILATION
SLOT (MAY REQUIRE ADDITIONAL SEISMIC
CONSIDERATION IN CERTAIN AREAS.
CHECK WITH LOCAL BUILDING OFFICIALS).

BATTENS WHERE REQUIRED

COUNTER BATTENS WHERE REQUIRED
NOMINAL 1" X 2"

UNDERLAYMENT

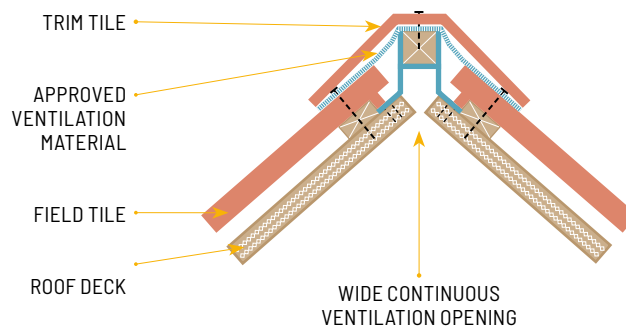

TRIM TILE

APPROVED
VENTILATION
MATERIAL

FIELD TILE

ROOF DECK

WIDE CONTINUOUS
VENTILATION OPENING

NOTES:

1. Refer to vent manufacturer instructions for products and limitations.
2. Ensure the vent material/weather blocking and/or ridge tile will provide sufficient coverage over field tile, if top course is held down from ridge to allow for ventilation, cut out slot in sheathing.
3. For recommended underlayment and fastening, see Page 13, Table 1A, 1B & 1C.
4. Dimensions shown are minimums and are intended to be approximate to all for reasonable tolerances due to field conditions.

Drawing shown depicts the application of all tile profiles. Unless otherwise noted, it would apply to either concrete or clay tiles.

PARAPET OR MANSARD CONDITION

MC-18C

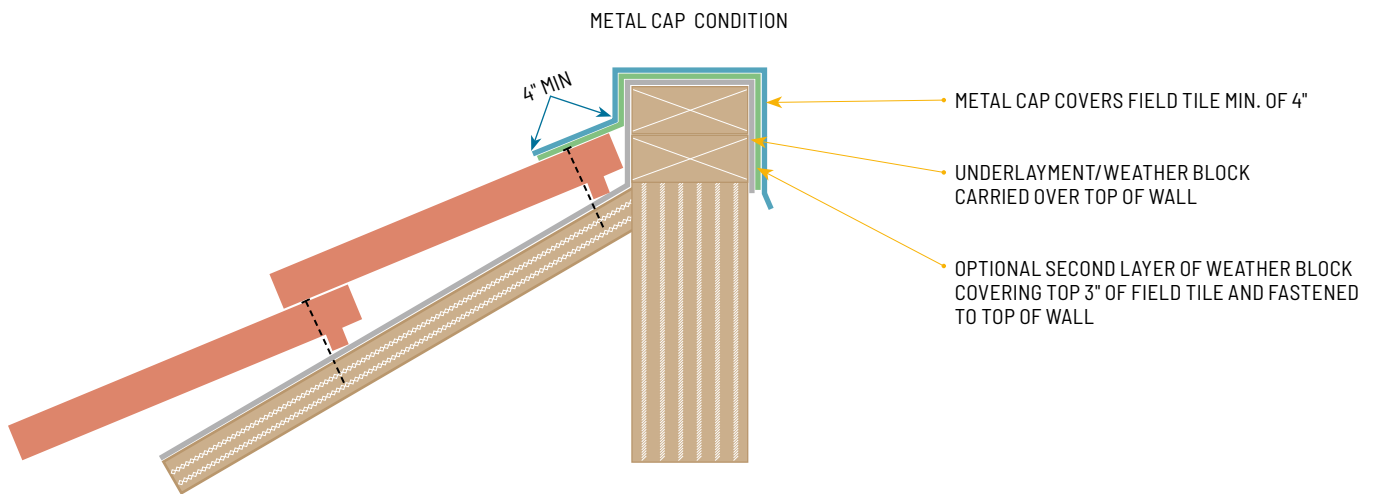
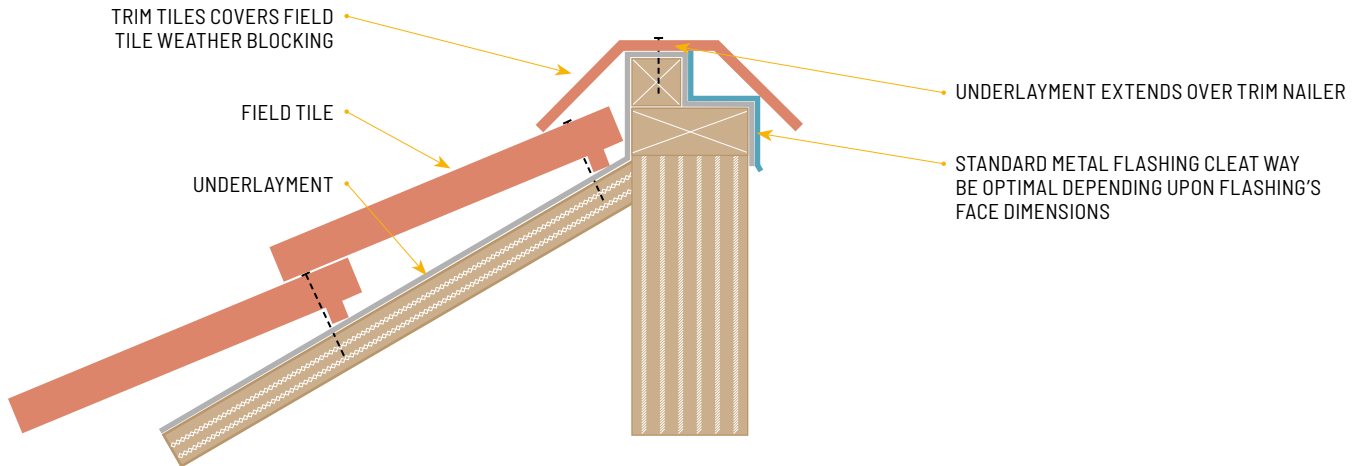

NOTES:

1. For recommended underlayment and fastening, see Page 13, Table 1A, 1B & 1C.
2. Dimensions shown are minimums and are intended to be approximate to all for reasonable tolerances due to field conditions.

Drawing shown depicts the application of all tile profiles. Unless otherwise noted, it would apply to either concrete or clay tiles.

MC-19

RAKE FLASHING EXAMPLES

See Drawing MC-12B For Additional Flashing Information

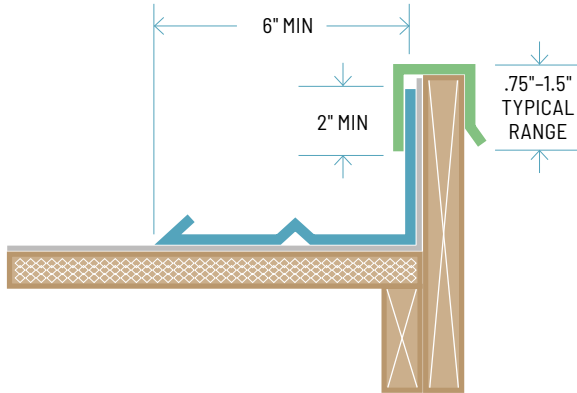

6" PAN DIMENSION WILL VARY BASED UPON EXPECTED WATER FLOW & DEPTH OF FLASHING. TYPICAL FOR DETAILS

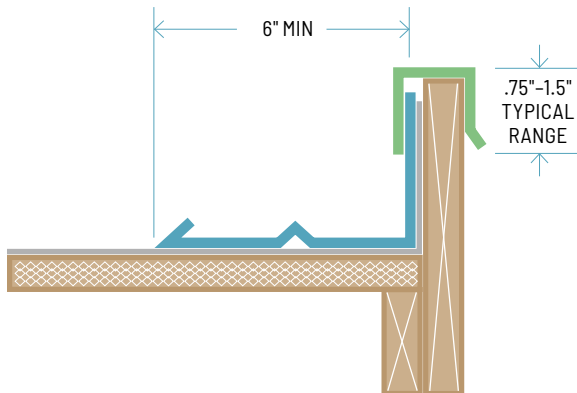
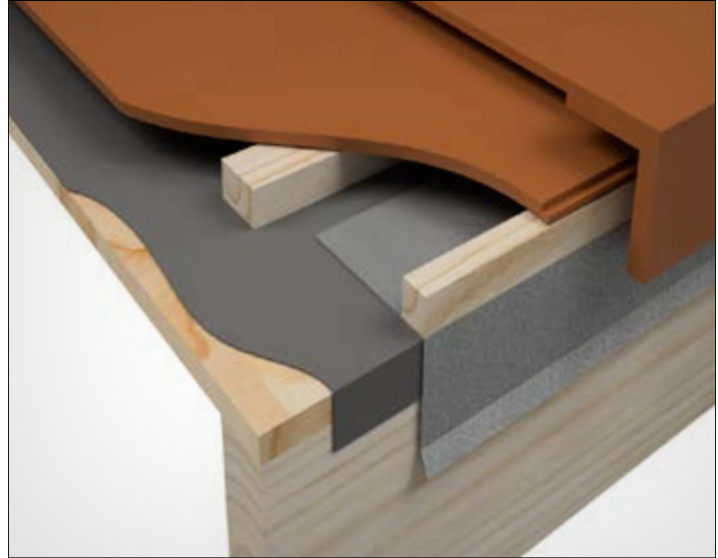

OPTIONAL CLEAT DRIP EDGE

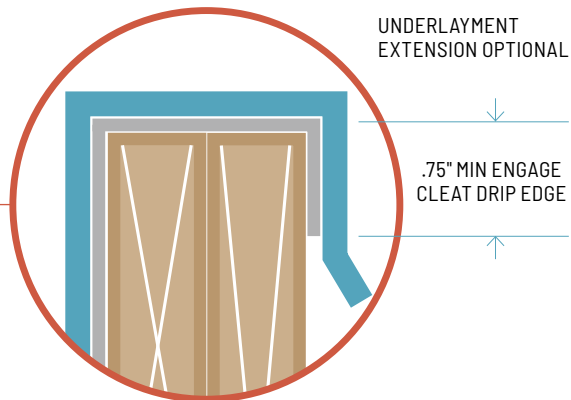
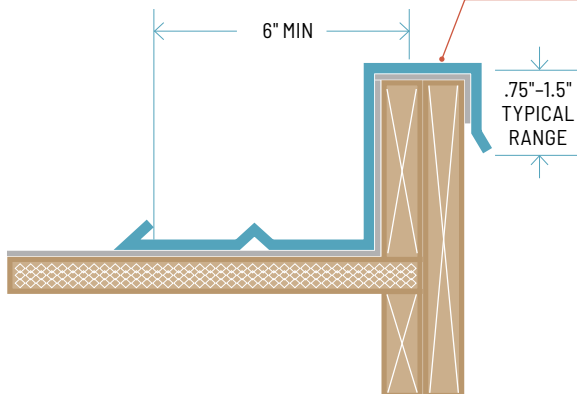
**NOTES:**

1. Flashing details may vary according to local weather conditions, roof size, location, slope of roof and contributory run-off area.
2. Underlayment shall extend a minimum of 4" up vertical wood blocking, wall, or top of fascia or gable trim.
3. Sheet metal flashing shall be a minimum of (No. 26 galvanized sheet metal) not less than 0.019 inch corrosion resistant metal (G90). See Table A for additional options.
4. Dimensions shown are minimums and are intended to be approximate to all for reasonable tolerances due to field conditions.
5. Rake flashing and wood nailer/trim board shall be raised above roof deck to a height greater than the height of the installed roof tile.

Drawing shown depicts the application of all tile profiles. Unless otherwise noted, it would apply to either concrete or clay tiles.

RAKE TILE INSTALLATION

MC-19A

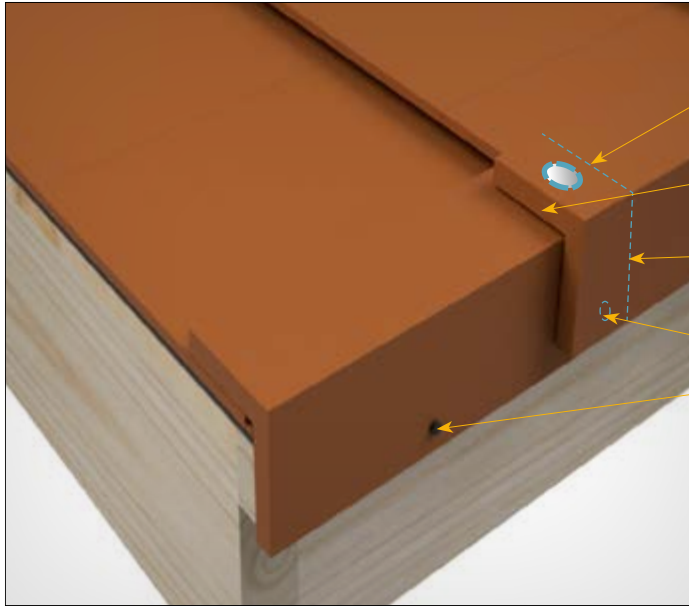

FOR ADDITIONAL FASTENING IN REGIONS SUBJECT TO HIGH WINDS OR SNOW ACCUMULATIONS, A MINIMUM 1" DAB OF CODE APPROVED ADHESIVE IS RECOMMENDED AT UNDERSIDE OF OVERLAP.

FACTORY-FINISHED BUTT END EXPOSED. PLACE THICK END UPSLOPE TOWARDS RIDGE.

CUT OFF HEAD END OF FIRST RAKE TILES SO FACTORY-FINISHED BUTT END IS FLUSH WITH EAVE COURSE TILES.

TWO CORROSION-RESISTANT FASTENERS, PER RAKE TILE, OF SUFFICIENT LENGTH TO PENETRATE THE 2X NAILER OR BARGE BOARD A MINIMUM OF 3/4". HEAD OF FASTENERS SHOULD BE LARGER THAN NAIL HOLE IN TRIM TILES.

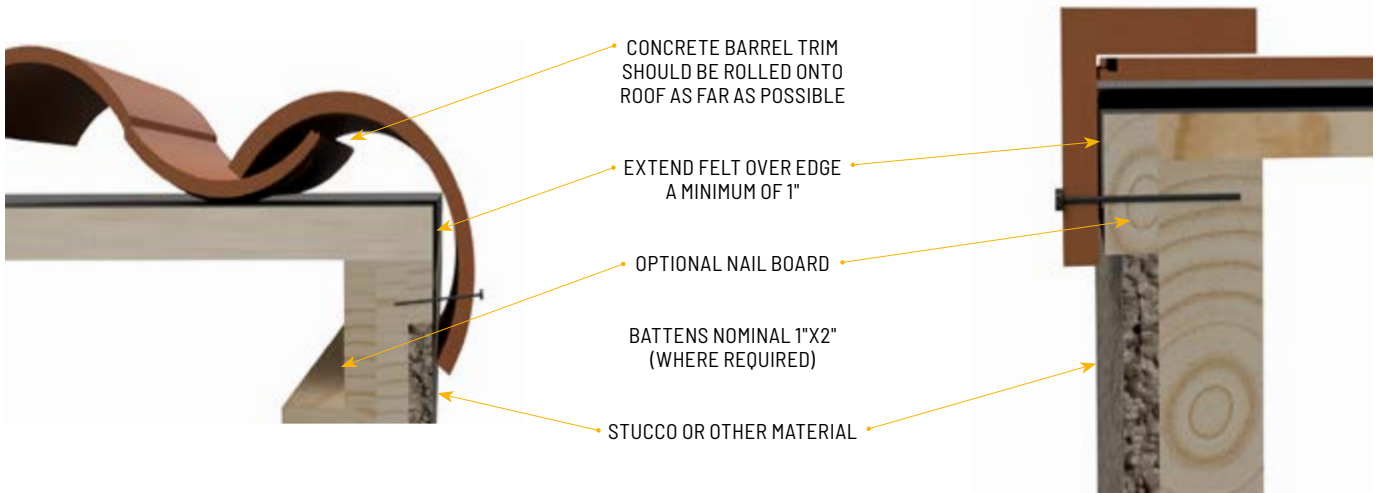

CONCRETE BARREL TRIM SHOULD BE ROLLED ONTO ROOF AS FAR AS POSSIBLE

EXTEND FELT OVER EDGE A MINIMUM OF 1"

OPTIONAL NAIL BOARD

BATTENS NOMINAL 1"X2" (WHERE REQUIRED)

STUCCO OR OTHER MATERIAL

NOTES:

1. Dimensions shown are minimums and are intended to be approximate to all for reasonable tolerances due to field conditions.
2. Rake tiles must fastened into a minimum nominal 2" gable fascia or equivalent dimension.
3. The fasteners must penetrate a minimum of 3/4" into dimensional wood lumber.
4. See TABLE A for additional flashing instructions.

Drawing shown depicts the application of all tile profiles. Unless otherwise noted, it would apply to either concrete or clay tiles.

MC-20

GABLE/EAVE INSTALLATION—BARREL TILE

Clay Tile Installations

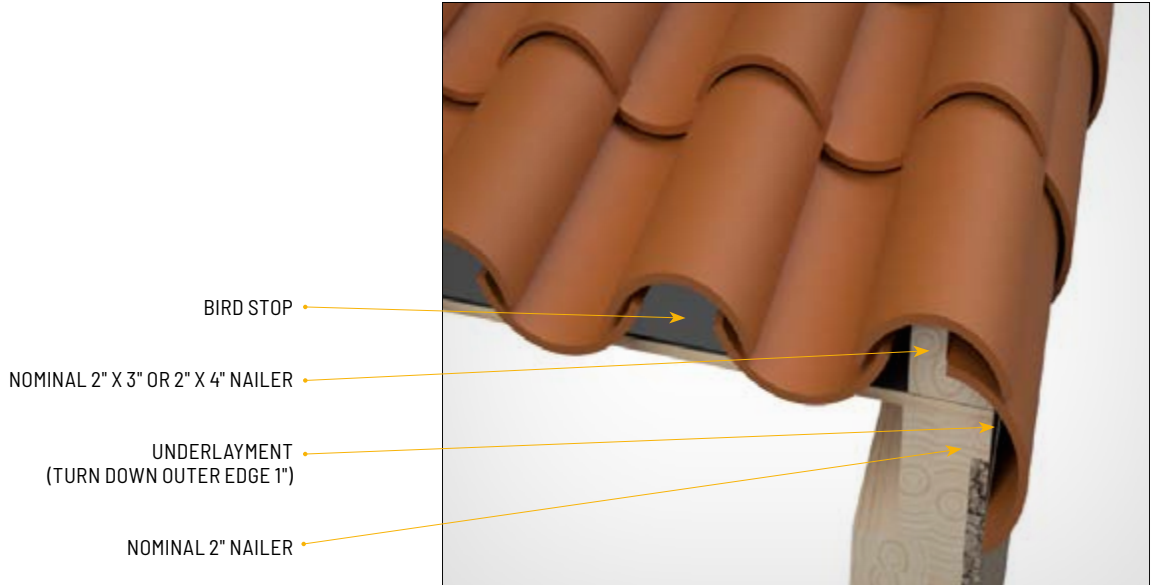

Appendix A

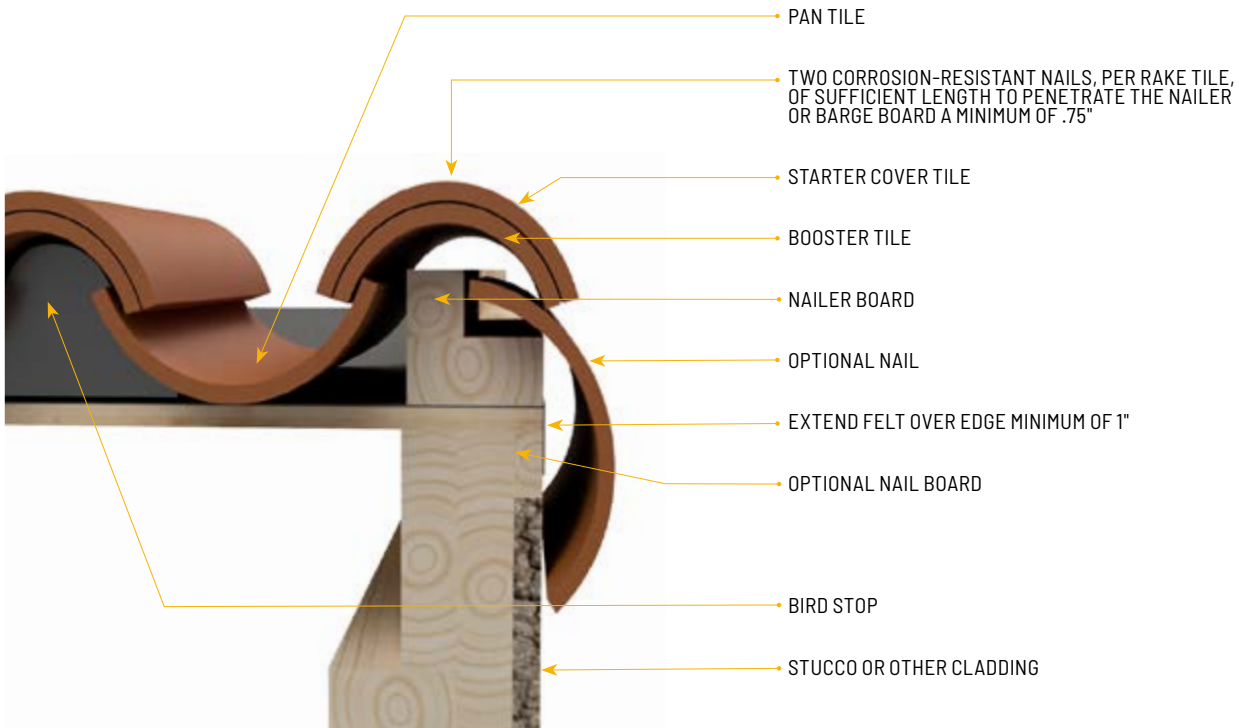

NOTES:

1. Dimensions shown are minimums and are intended to be approximate to all for reasonable tolerances due to field conditions.
2. See TABLE A for additional flashing instructions.

Drawing shown depicts the application of all tile profiles. Unless otherwise noted, it would apply to either concrete or clay tiles.

RAKE TILE INSTALLATION—BARREL TILE

MC-20A



EAVE DRIP EDGE FLASHING
NOT SHOWN FOR CLARITY

NOMINAL 2" X 3" OR 2" X 4" NAILER

NOMINAL 2" X 2" NAILER

UNDERLAYMENT

HIGH PROFILE TILE

OPTIONAL: PAN OR STRAW NAIL

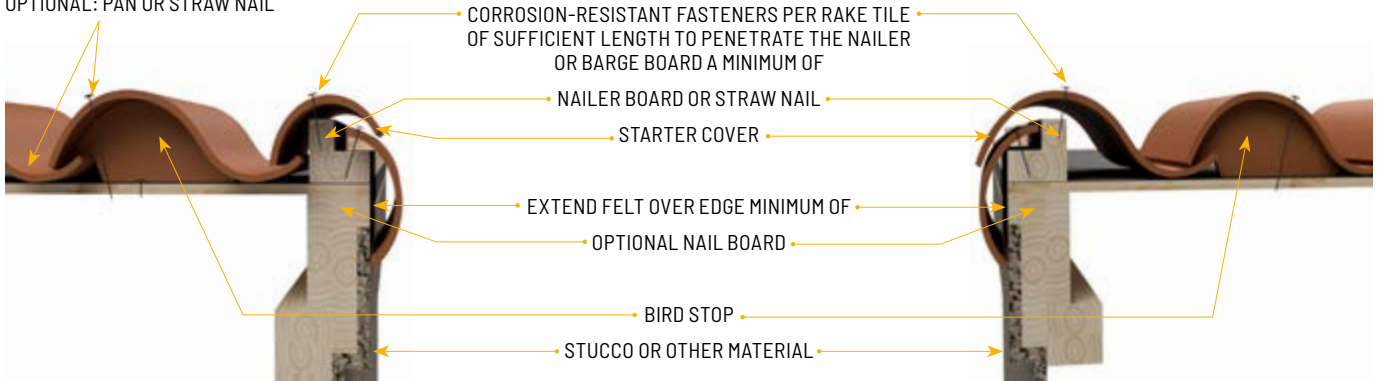

NOTES:

1. Dimensions shown are minimums and are intended to be approximate to all for reasonable tolerances due to field conditions.

Drawing shown depicts the application of all tile profiles. Unless otherwise noted, it would apply to either concrete or clay tiles.

MC-21

ROOF VENTS (OFF RIDGE)

Vents To Be Installed Per Vent Manufacturer Instructions

FIELD TILE

VENT HOOD TILE FLASHINGS

NOTCH OR OPEN NOSE OF TILE FOR DRAINAGE

ADHESIVE WEATHER BLOCKING
(OVER TILE UNDER
FLASHING)

DECK FLASHING, SEE NOTE 2

UNDERLAYMENT

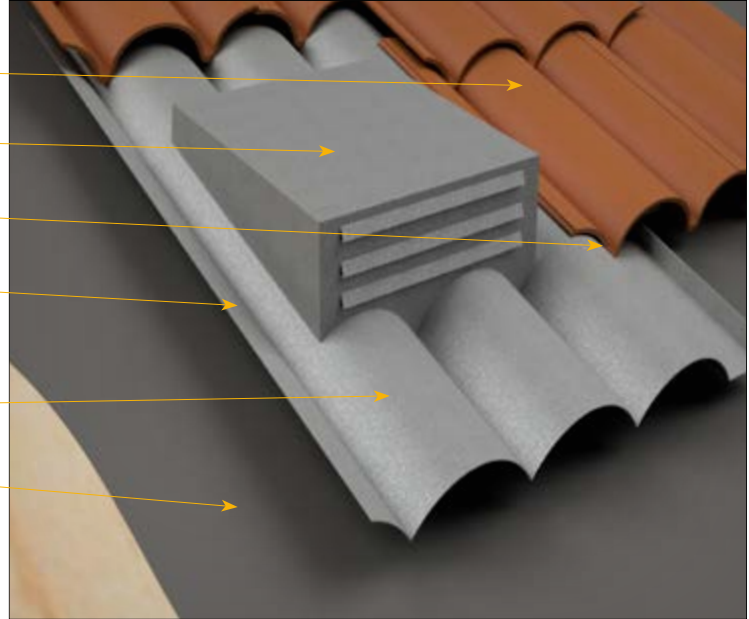

NOTE: CHECK LOCAL CODE REQUIREMENTS FOR VERMIN SCREENING

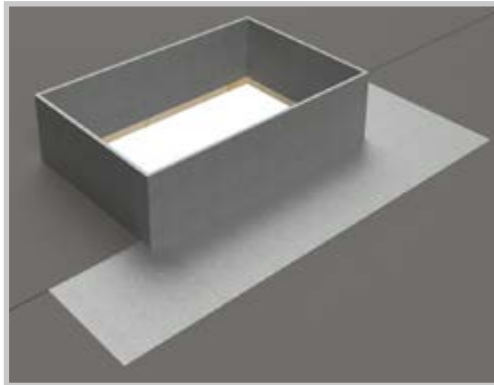

UNDERLAYMENT DETAIL AT DECK FLASHING

VENTED TILES AVAILABLE TO MATCH
INDIVIDUAL TILE MANUFACTURER PROFILES**NOTES:**

1. One layer of No. 30 asphalt-saturated felt complying with ASTM D226 Type II (ASTM D4869 Type IV) or approved equal is required as a minimum underlayment on all tile roof applications. Other underlayments as approved by local building officials will be allowed.
2. A secondary flashing, as depicted in the left inset, is required around penetrations to prevent moisture intrusion should water reach the underlayment, under the roof tile. This secondary or deck flashing is required with all tiles.
3. For climates with wind driven rain or blowing snow, consult local building official for approved applications.
4. Metal flashing shall be a minimum of (No. 26 galvanized sheet metal) not less than 0.019 inch corrosion resistant metal (G90).
5. See Table A for additional options.

Drawing shown depicts the application of all tile profiles. Unless otherwise noted, it would apply to either concrete or clay tiles.

SLOPE CHANGE APPLICATIONS

MC-22

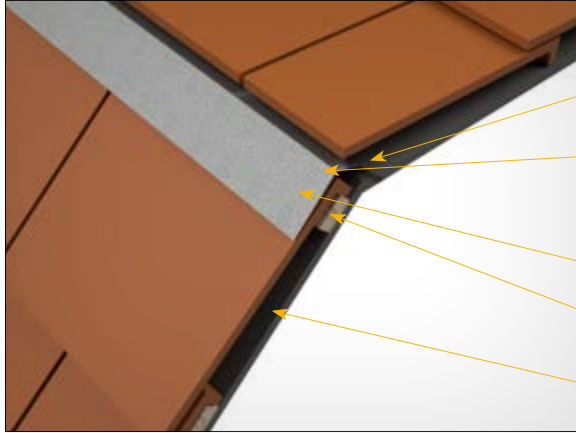

- UNDERLAYMENT, SEALANT OR SEAL STRIP OVER TOP OF FLASHING
- MALLEABLE FLASHING OR RIGID METAL WITH WEATHER BLOCKING FOR PROFILE TILES. FOR FLAT TILES, PREFORMED, METAL, WITH HEMMED EDGE(S), MAY BE USED OVER BREAK FLASHING TO PROVIDE A SNUG FIT.
- FLASHING MUST LAP TILE 3" MINIMUM
- BATTEN (WHERE REQUIRED)
- UNDERLAYMENT

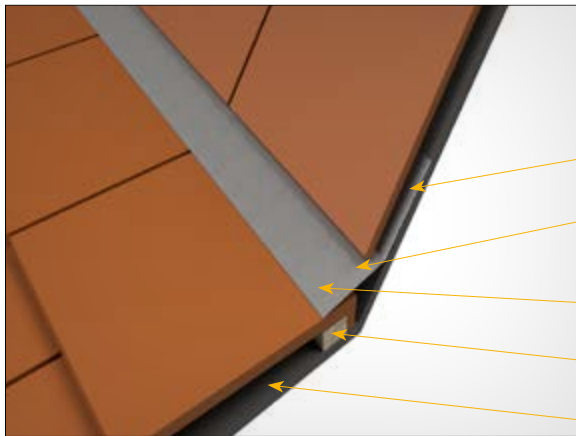

- OPTION 1—WITH METAL TRANSITION FLASHING
- UNDERLAYMENT, SEALANT OR SEAL STRIP OVER TOP OF FLASHING
 - MALLEABLE METAL FLASHING OR RIGID WEATHER BLOCKING FOR PROFILE TILES. FOR FLAT TILES, PREFORMED, METAL, WITH HEMMED EDGE(S), MAY BE USED OVER BREAK FLASHING TO PROVIDE A SNUG FIT.
 - 3" MIN.
 - BATTEN WHERE REQUIRED
 - UNDERLAYMENT

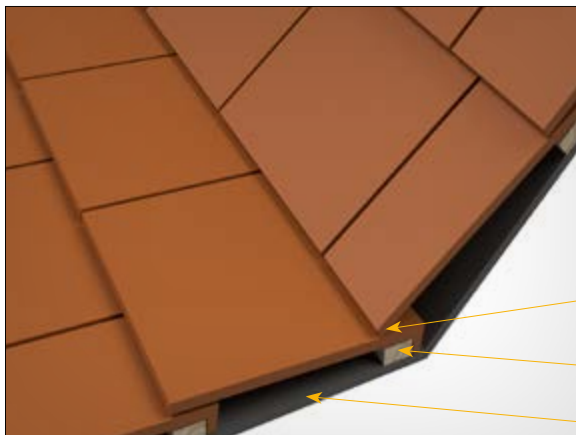

- OPTION 2—WITHOUT METAL
- INCREASE HEADLAP OR PROVIDE WEATHER BLOCKING TO STOP BACK FLOW OF WATER AT TRANSITION SEAL AS REQUIRED.
 - BATTEN WHERE REQUIRED
 - UNDERLAYMENT

NOTES:

1. One layer of No. 30 asphalt-saturated felt complying with ASTM D226 Type II (ASTM D4869 Type IV) or approved equal is required as a minimum underlayment on all tile roof applications. Other underlayments as approved by local building officials will be allowed.
2. Dimensions shown are minimums and are intended to be approximate to all for reasonable tolerances due to field conditions.

Drawing shown depicts the application of all tile profiles. Unless otherwise noted, it would apply to either concrete or clay tiles.

MC-23

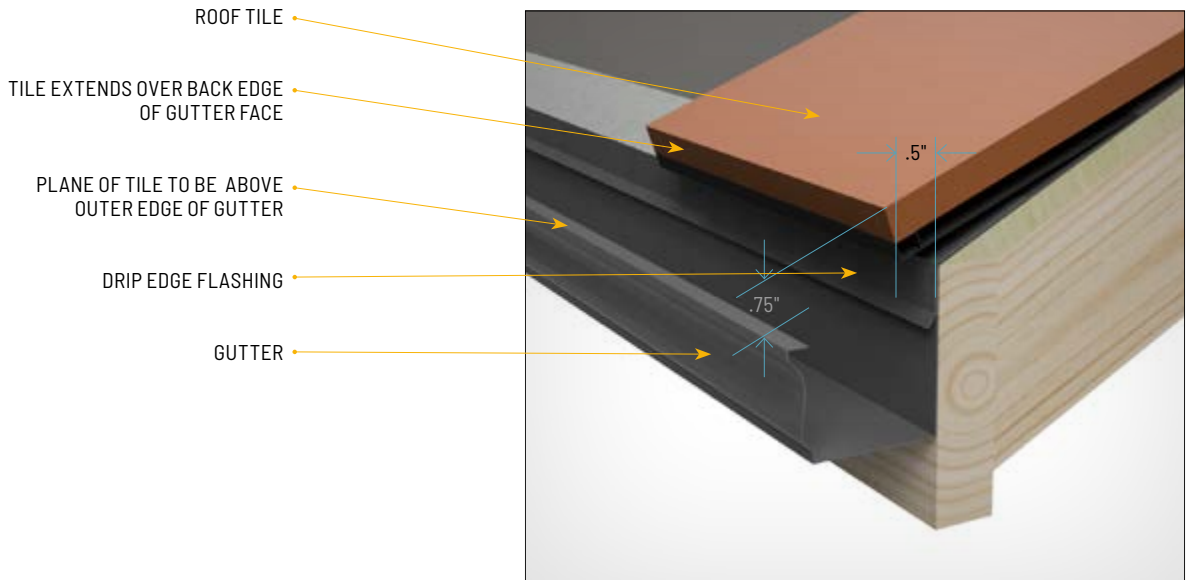
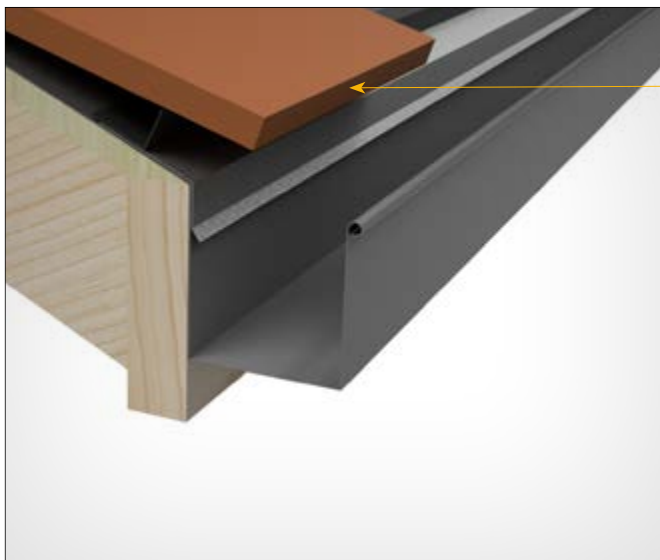
GUTTERS**Optional Recessed First Course For Ice Damming**

NOTES: This drawing is included to show one style of gutter installation since gutter conditions vary by climate conditions. Please contact your local gutter manufacturer for specific installation requirements.

NOTES:

1. For recommended underlayment and fastening, see Page 13, Table 1A, 1B & 1C.
2. An eave drip flashing is required with stucco fascia, EIFS (Exterior Insulated Finish System) and flush fascia perimeter edges.
3. Battens for tile with projecting anchor lugs are optional for slopes between 3:12 less than or equal to 7:12. Direct deck nailing requirements may be permissible.
4. Eave closures should be the height equal to combined thickness of batten system and thickness of one course of tile.
5. Dimensions shown are minimums and are intended to be approximate to all for reasonable tolerances due to field conditions.

Drawing shown depicts the application of all tile profiles. Unless otherwise noted, it would apply to either concrete or clay tiles.

TILE REPAIR / REPLACEMENT

MC-24

When replacing an individual tile, one method is to remove the broken tile by breaking into smaller pieces with a hammer or other acceptable tool. This will minimize the disturbance of the surrounding tiles. Once the tile has been removed, any remaining fasteners should be removed and the resulting holes in the underlayment cleaned and patched.

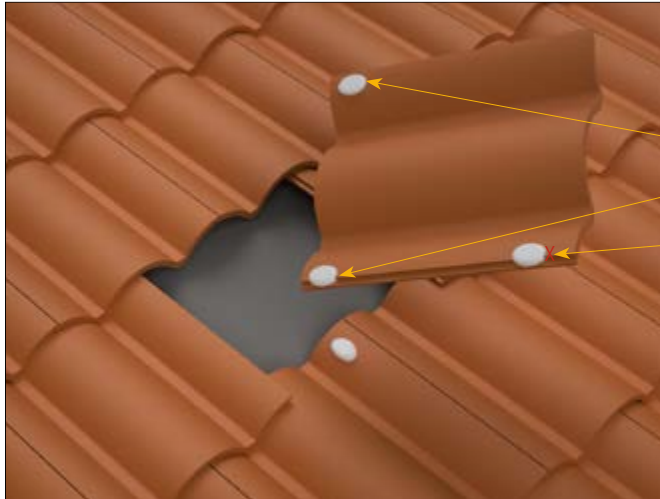

FOR APPLICATIONS WITHOUT BATTENS

YES (PROPER LOCATION)

NO (IMPROPER LOCATION)

TILE ADHESIVE (CODE APPROVED SEE PAGE 8)

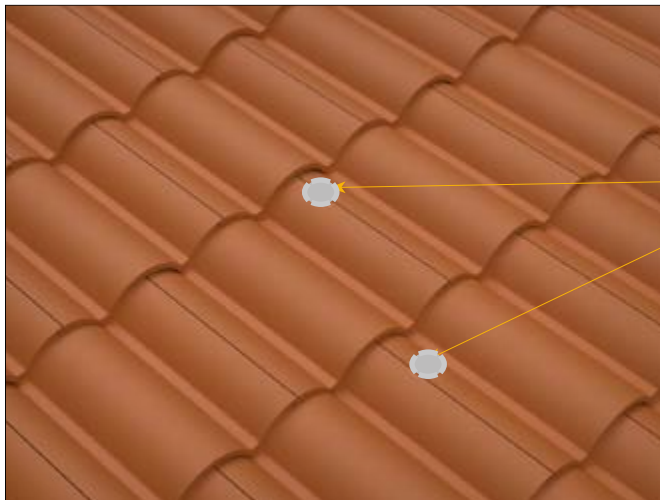

WEDGE SURROUNDING TILES UP AND SLIDE TILE INTO PLACE. (FOR SLOPES OVER 7:12 – BATTENS REQUIRED)
REMOVE BROKEN TILE AND FASTENER. WEDGE SURROUNDING TILES, APPLY CODE APPROVED ROOF TILE ADHESIVES AND SLIDE NEW TILE IN PLACE.

TILE ADHESIVE (CODE APPROVED, SEE PAGE , UNDER THE TILE. NOT ON WATER CHANNEL)

Note: The replacement tile may be slipped into place and fastened with an approved tile adhesive. It is important that the adhesive is placed in a position that will assure contact with adjacent tiles without affecting the flow of water. If adhesive is applied to interlocking water channel, it must be placed above the headlap to avoid water damming.

REMOVE ANY SHIM THAT HAD BEEN USED DURING THE REPAIR PROCESS AND ENSURE THAT TILES SURROUNDING THE REPLACED PIECE PROPERLY FIT AND ARE SEATED.

MC-24A

TILE REPAIR / REPLACEMENT—CONTINUED

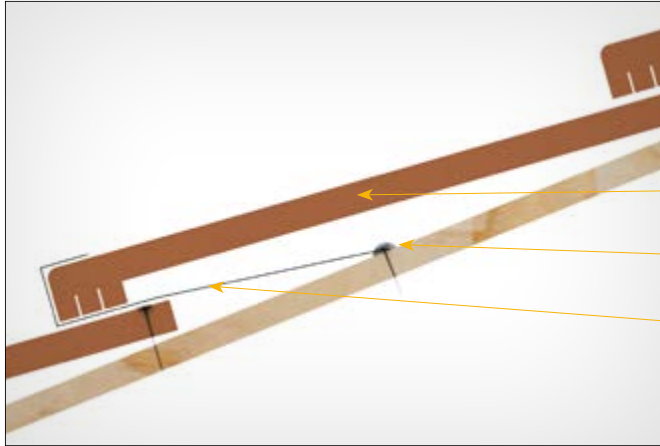

REPLACEMENT TILE

SEAL WITH MASTIC

WIRE

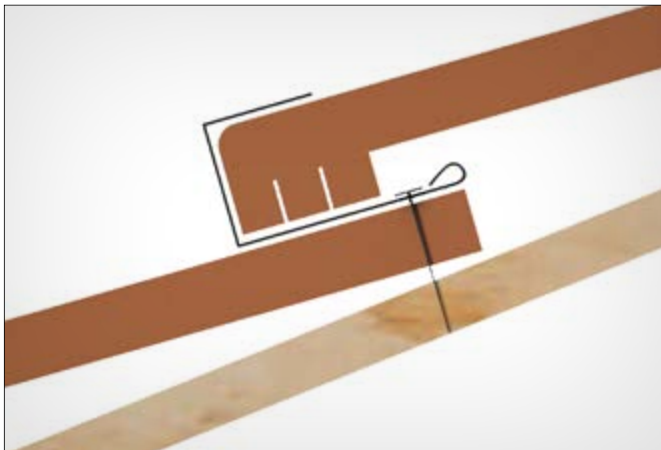

"L" HOOK

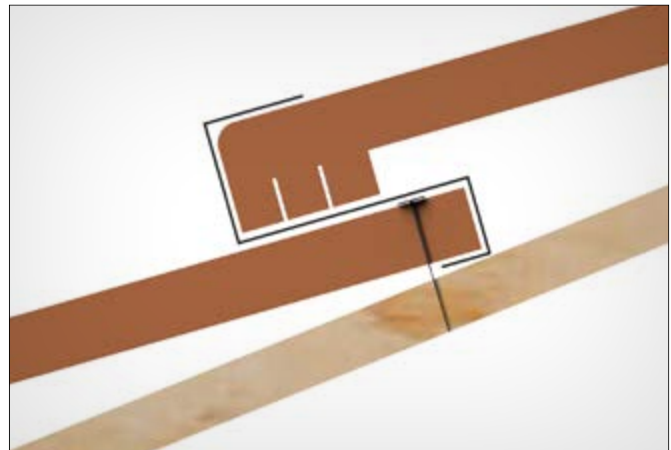

"S" HOOK

NOTES:

1. Clear area of debris where broken tile is to be placed. Remove fasteners from previous tile. Fasteners may be removed by using slate ripper or, in the case of screws a hacksaw blade.
2. Lift the nose of tile in course above. Then slide replacement tile, underneath the overlapping tile and over the hook, then slide tile into the hook and down the "L" hooks underneath top course of course below.
3. Adjust replacement tile to align or interlock (depending on the tile type) with tiles on either side.
4. Another method is to fasten a 12 gauge copper wire into the deck, replacing the tile and then bending the exposed wire. A sheet metal (e.g. copper) strip can also be applied.
5. Make adjustments for field tile.

Drawing shown depicts the application of all tile profiles. Unless otherwise noted, it would apply to either concrete or clay tiles.

SPECIALTY INSTALLATIONS—PRE ENGINEERED ROOF

MC-25

Installation on Metal Deck—Considerations Ribs Running Parallel to Roof Slope

FOR INFORMATIONAL PURPOSES ONLY—THESE HAVE NOT BEEN EVALUATED BY UNIFORM ES.

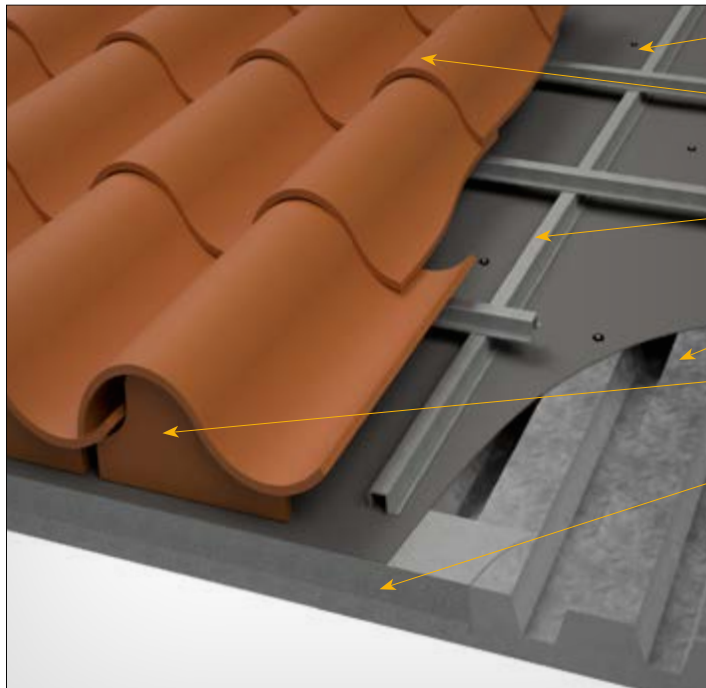

CODE APPROVED REINFORCED UNDERLAYMENT ATTACHED WITH MECHANICALLY DRIVEN CAPPED FASTENERS

TILE FASTENED TO BATTENS WITH SELF-TAPPING SCREWS OR OTHER CODE APPROVED FASTENERS

METAL BATTENS FASTENED TO METAL DECK WITH SCREWS OR OTHER CODE APPROVED FASTENERS

METAL DECK

EAVE RISER STRIP OR RAISED BIRD STOP AS DESIGNED

DRIP EDGE FLASHING

FOR FIRE-RATED SYSTEMS, ADDITIONAL COMPONENTS MAY BE REQUIRED.

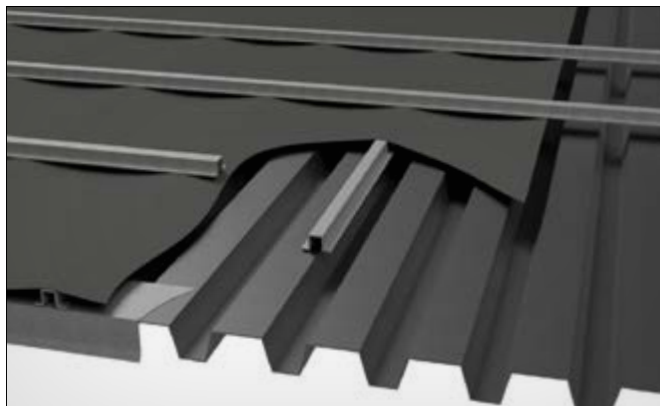

The pre-engineered roof systems are included for informational purposes only and are not recognized under evaluation reports for roof tiles

NOTES:

1. Vertical battens to be metal or as approved or designed as per metal deck manufacturer.
2. For recommended underlayment and fastening, see Page 13, Table 1A, 1B & 1C.
3. An eave drip flashing is required with stucco fascia, EIFS (Exterior Insulated Finish System) and flush fascia perimeter edges.
4. Eave closures should be the height equal to combined thickness of batten system and thickness of one course of tile.
5. Dimensions shown are minimums and are intended to be approximate to all for reasonable tolerances due to field conditions.

Drawing shown depicts the application of all tile profiles. Unless otherwise noted, it would apply to either concrete or clay tiles.

MC-25A

SPECIALTY INSTALLATIONS—PRE ENGINEERED ROOF

Installation on Metal Deck—Considerations
 Ribs Running Perpendicular To Roof Slope With Rigid Sheathing

FOR INFORMATIONAL PURPOSES ONLY—THESE HAVE NOT BEEN EVALUATED BY UNIFORM ES.

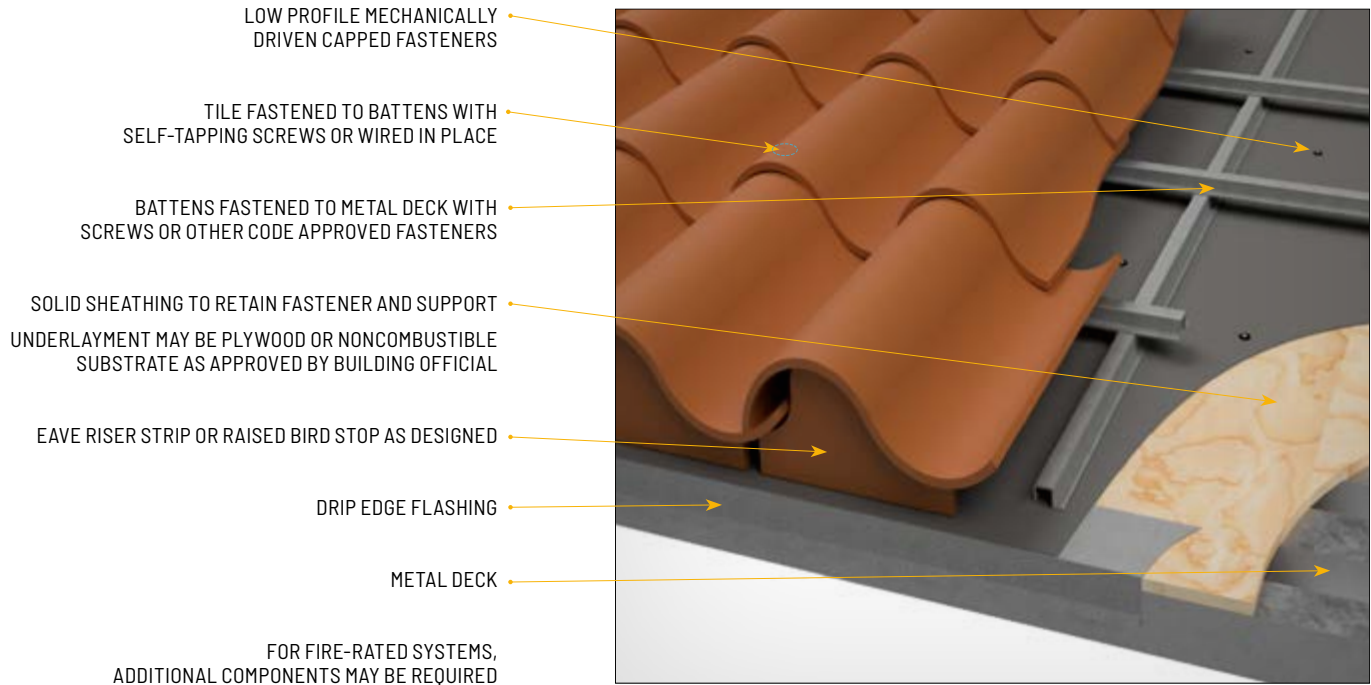

The pre-engineered roof systems are included for informational purposes only and are not recognized under evaluation reports for roof tiles

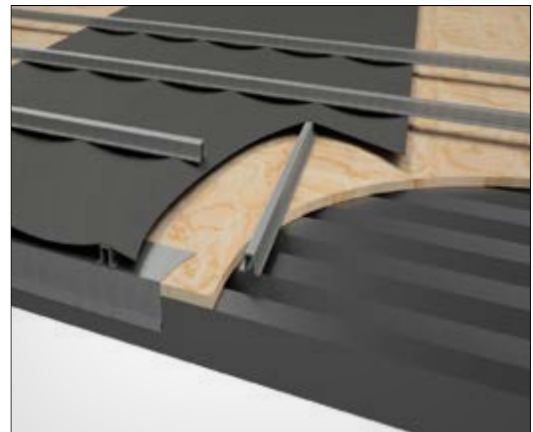

NOTES:

1. Vertical battens to be metal or as approved or designed as per metal deck manufacturer
2. For recommended underlayment and fastening, see Page 13, Table 1A, 1B & 1C
3. An eave drip flashing is required with stucco fascia, EIFS (Exterior Insulated Finish System) and flush fascia perimeter edges.
4. The fasteners shall penetrate a minimum of 3/4" into dimensional wood decking or pass through wood panel sheathing which ever is less.
5. Eave closures should be the height equal to combined thickness of batten system and thickness of one course of tile.
6. On Type I (Non-Combustible) building, all components must be fire-resistant as approved by local building official.
7. Dimensions shown are minimums and are intended to be approximate to all for reasonable tolerances due to field conditions.

Drawing shown depicts the application of all tile profiles. Unless otherwise noted, it would apply to either concrete or clay tiles.

SPECIALTY INSTALLATIONS—PRE ENGINEERED ROOF

MC-25B

Installation on Metal Deck—Optional Considerations Ribs Running Perpendicular To Roof Slope

FOR INFORMATIONAL PURPOSES ONLY—THESE HAVE NOT BEEN EVALUATED BY UNIFORM ES.

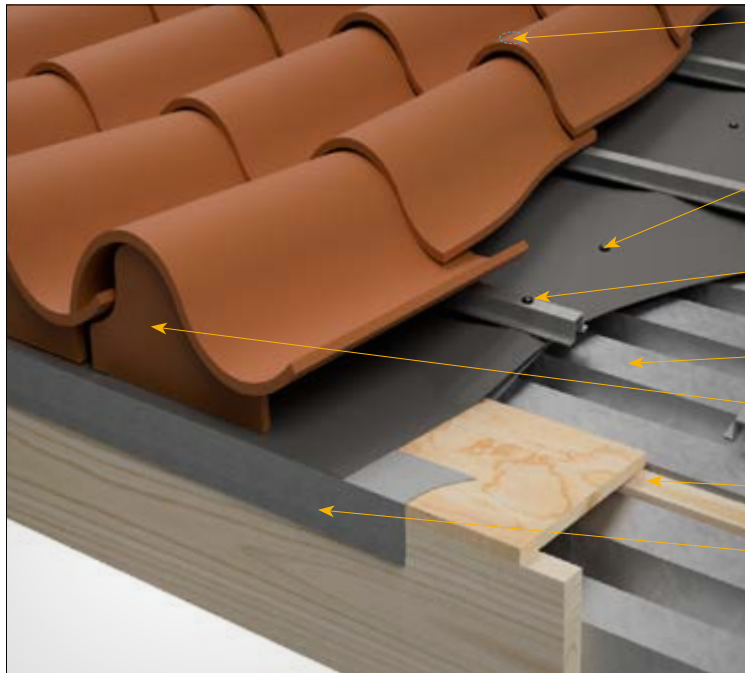

TILE FASTENED TO BATTENS WITH SELF-TAPPING CREWS OR WIRED IN PLACE. HEAD OF FASTENERS SHALL BE LARGER THAN NAIL HOLE IN TILE

CODE APPROVED REINFORCED DRAPED UNDERLAYMENT ATTACHED TO COUNTER BATTENS WITH MECHANICALLY DRIVEN CAPPED FASTENERS

BATTENS FASTENED TO METAL DECK WITH SCREWS OR OTHER CODE APPROVED FASTENERS

METAL DECK

EAVE RISER OR BIRD STOP

SUPPORT SHIM (WHERE REQUIRED)

PERIMETER DRIP EDGE FLASHING

FOR FIRE-RATED SYSTEMS, ADDITIONAL COMPONENTS MAY BE REQUIRED

The pre-engineered roof systems are included for informational purposes only and are not recognized under evaluation reports for roof tiles

NOTES:

1. Vertical battens to be metal or as approved or designed as per metal deck manufacturer.
2. For recommended underlayment and fastening, see Page 13, Table 1A, 1B & 1C.
3. An eave drip flashing is required with stucco fascia, EIFS (Exterior Insulated Finish System) and flush fascia perimeter edges.
4. Eave closures should be the height equal to combined thickness of batten system and thickness of one course of tile.
5. On Type I (Non-Combustible) building, all components must be fire-resistant as approved by local building official.
6. Dimensions shown are minimums and are intended to be approximate to all for reasonable tolerances due to field conditions.

Drawing shown depicts the application of all tile profiles. Unless otherwise noted, it would apply to either concrete or clay tiles.

MC-25C

SPECIALTY INSTALLATIONS— PRE ENGINEERED ROOF

Installation on Metal Deck—Considerations
Adhesive Based Systems—Solid Sheathing

FOR INFORMATIONAL PURPOSES ONLY—THESE HAVE NOT BEEN EVALUATED BY UNIFORM ES.

- SELF-ADHERING UNDERLAYMENT COMPATIBLE WITH SUBSTRATE
- TILES FASTENED ACCORDING TO ADHESIVE MANUFACTURERS CODE APPROVED INSTRUCTIONS
- RIGID SHEATHING TO SUPPORT UNDERLAYMENT MAY BE PLYWOOD OR NON-COMBUSTIBLE SUBSTRATE AS APPROVED BY LOCAL BUILDING OFFICIAL
- EAVE RISER OR BIRD STOP
- PERIMETER DRIP EDGE FLASHING
- METAL DECK
- FOR FIRE-RATED SYSTEMS, ADDITIONAL COMPONENTS MAY BE REQUIRED

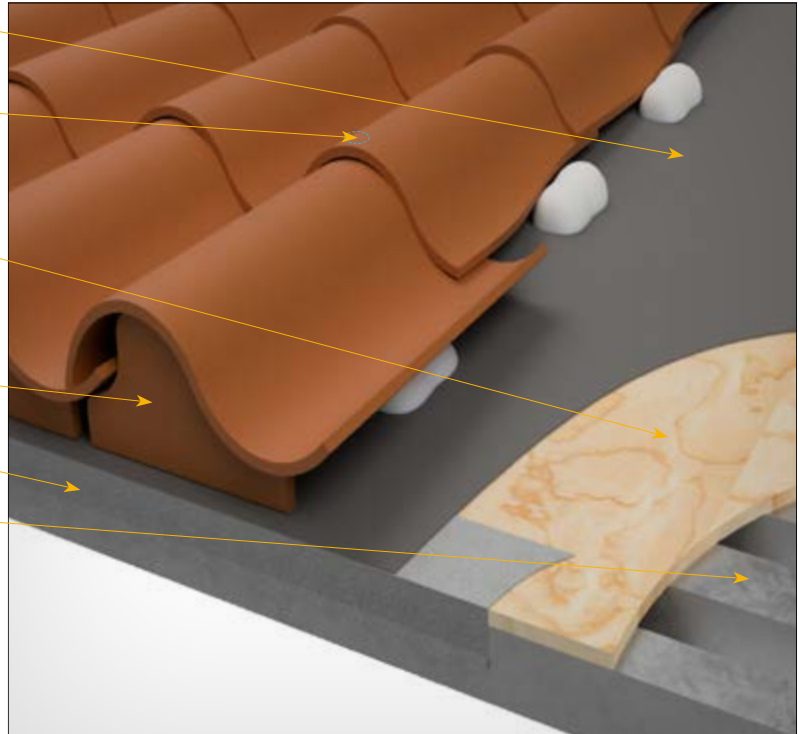

NOTE: ADHESION OF UNDERLAYMENT TO SUBSTRATE SHALL BE IN ACCORDANCE WITH ASSEMBLIES RECOGNIZED IN A CURRENT ICC-ES EVALUATION REPORT FOR ROOF TILE ADHESIVES EVALUATED TO THE REQUIREMENTS OF AC-152.

The pre-engineered roof systems are included for informational purposes only and are not recognized under evaluation reports for roof tiles

NOTES:

1. On Type I (Non-Combustible) building, all components must be fire-resistant as approved by local building official.
2. Dimensions shown are minimums and are intended to be approximate to all for reasonable tolerances due to field conditions.

Drawing shown depicts the application of all tile profiles. Unless otherwise noted, it would apply to either concrete or clay tiles.

SPECIALTY INSTALLATIONS –PRE ENGINEERED ROOF

MC-26

Installation on Metal Deck—Considerations Adhesive Based Systems—On Counter Batten

FOR INFORMATIONAL PURPOSES ONLY—THESE HAVE NOT BEEN EVALUATED BY UNIFORM ES.

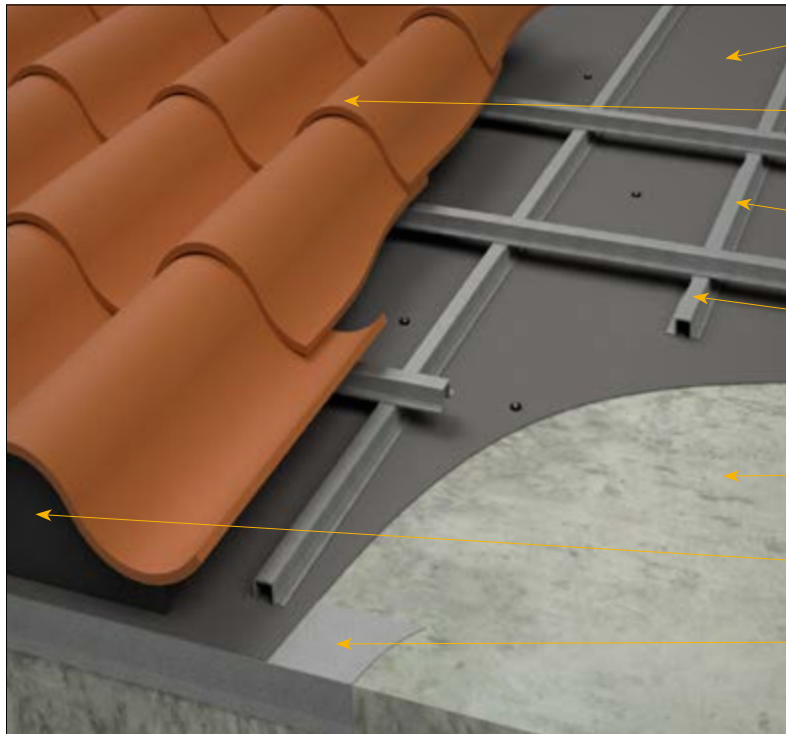

- UNDERLAYMENT OR CODE APPROVED SEALED SYSTEM
 - TILE FASTENED TO BATTENS WITH SELF-TAPPING SCREWS OR WIRED IN PLACE, HEAD OF FASTENER SHALL BE LARGER THAN NAIL HOLE IN TILE
 - BATTENS FASTENED TO METAL DECK WITH SCREWS OR OTHER CODE APPROVED FASTENERS
 - VERTICAL COUNTER BATTENS FASTENED TO CONCRETE DECK WITH SCREWS, EXPANDING LEAD PINS, OR OTHER APPROVED FASTENERS AS DESIGNED
 - CONCRETE DECK OR APPROVED STRUCTURAL SUBSTRATE
 - EAVE RISER OR BIRD STOP
 - PERIMETER EDGE DRIP FLASHING
- FOR FIRE-RATED SYSTEMS, ADDITIONAL COMPONENTS MAY BE REQUIRED

OPTION: CODE APPROVED REINFORCED DRAPED UNDERLAYMENT

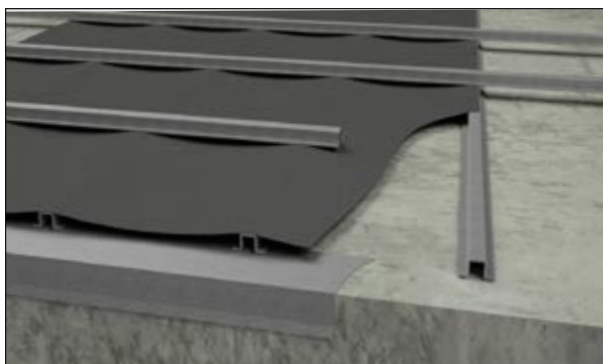

The pre-engineered roof systems are included for informational purposes only and are not recognized under evaluation reports for roof tiles

NOTES:

1. Vertical battens to be of metal or as approved or designed as per metal deck manufacturer.
2. Dimensions shown are minimums and are intended to be approximate to all for reasonable tolerances due to field conditions.

Drawing shown depicts the application of all tile profiles. Unless otherwise noted, it would apply to either concrete or clay tiles.

MC-26A

SPECIALTY INSTALLATIONS—PRE ENGINEERED ROOF

Installation On Metal Deck—Considerations
Adhesive Based Systems—Direct To Deck

FOR INFORMATIONAL PURPOSES ONLY—THESE HAVE NOT BEEN EVALUATED BY UNIFORM ES.

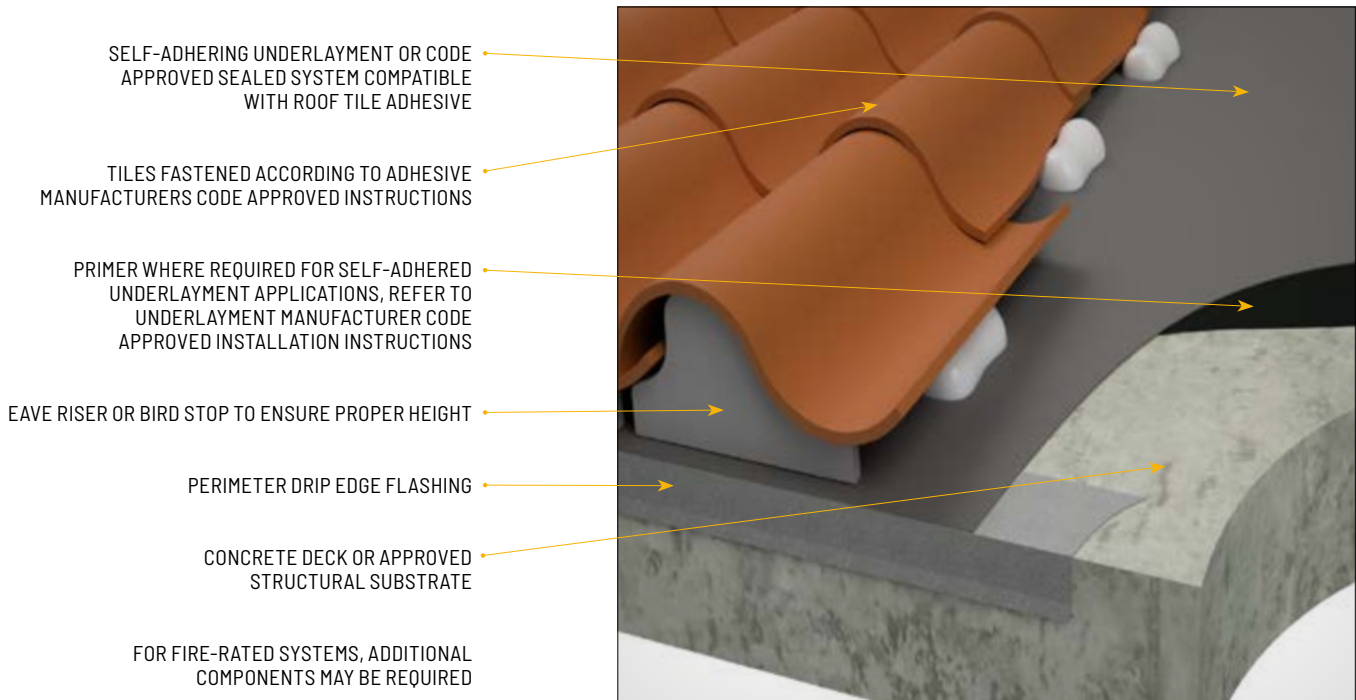

NOTE: ADHESION OF UNDERLAYMENT TO SUBSTRATE SHALL BE IN ACCORDANCE WITH ASSEMBLIES RECOGNIZED IN A CURRENT ICC-ES EVALUATION REPORT FOR ROOF TILE ADHESIVES EVALUATED TO THE REQUIREMENTS OF AC-152.

The pre-engineered roof systems are included for informational purposes only and are not recognized under evaluation reports for roof tiles

NOTES:

1. Dimensions shown are minimums and are intended to be approximate to all for reasonable tolerances due to field conditions.

Drawing shown depicts the application of all tile profiles. Unless otherwise noted, it would apply to either concrete or clay tiles.

SPECIALTY INSTALLATIONS— PRE ENGINEERED ROOF

MC-27

Wire Tie Systems On S-Tile

FOR INFORMATIONAL PURPOSES ONLY—THESE HAVE NOT BEEN EVALUATED BY UNIFORM ES.

AT TOP & BOTTOM ANCHOR WRAP TWISTED WIRE BACK ON ITSELF MIN. 3 TIME FULL TURNS.



IN-LINE ANCHORS TO BE SPACED AND FASTENED AS REQUIRED. ANCHORS TO BE AS SHOWN.

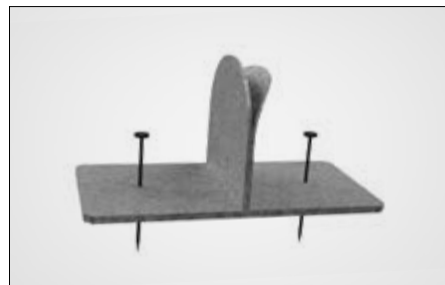

1. SET CLIP

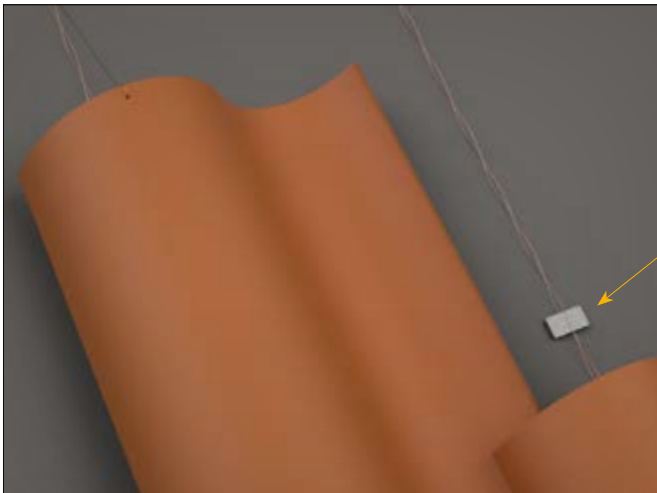

2. ANCHOR WIRE

CODE APPROVED FASTENING SYSTEM

DECK ANCHORS INSTALLED PER ANCHOR MANUFACTURERS ICC-ES EVALUATION REPORT

TILE WIRE TO BE WRAPPED AROUND ITSELF 3 FULL REVOLUTIONS AT EACH JUNCTION- TYPICAL FOR ALL TILES

OPTIONAL: NOSE CLIPS ON STEEP SLOPES OR HIGH WIND ZONE REQUIREMENTS
SPECIFY DIMENSION PER MANUFACTURER SPECIFICATIONS FOR ALL WIRE

The pre-engineered roof systems are included for informational purposes only and are not recognized under evaluation reports for roof tiles

MC-27A

SPECIALTY INSTALLATIONS—PRE ENGINEERED ROOF

Wire Tile Systems On Clay S-Tile

AT TOP & BOTTOM ANCHOR WRAP TWISTED WIRE BACK ON ITSELF MIN. 3 TIME FULL TURNS.



IN-LINE ANCHORS TO BE SPACED AND FASTENED AS REQUIRED. ANCHORS TO BE AS SHOWN.

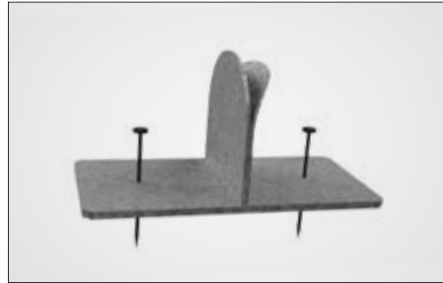

1. SET CLIP

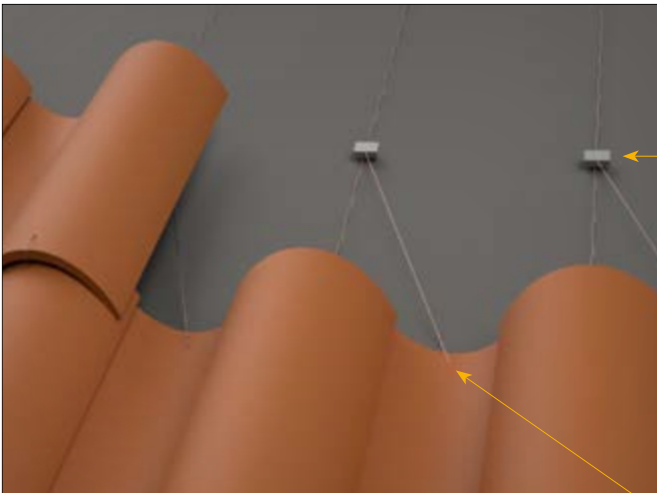

2. ANCHOR WIRE

CODE APPROVED FASTENING SYSTEM
 DECK ANCHORS INSTALLED PER ANCHOR MANUFACTURERS
 ICC-ES EVALUATION REPORT
 TILE WIRE TO BE WRAPPED AROUND ITSELF 3 FULL
 REVOLUTIONS AT EACH JUNCTION- TYPICAL FOR ALL TILES

OPTIONAL: NOSE CLIPS ON STEEP SLOPES OR HIGH WIND ZONE AS REQUIRED.
 COVER TILES TO BE ATTACHED OR OTHERWISE SECURED.
 UNDERLAYMENT NOT SHOWN FOR CLARITY.

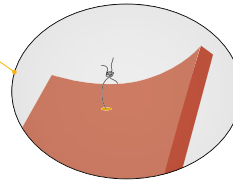

WIRE ATTACHMENT

The pre-engineered roof systems are included for informational purposes only and are not recognized under evaluation reports for roof tiles

Drawing shown depicts the application of all tile profiles. Unless otherwise noted, it would apply to either concrete or clay tiles.

SPECIALTY INSTALLATIONS

Nailer Installations—(Optional) Cap & Pan

MC-27B



2 X NAILER TO SUPPORT THE COVER TILE/CAP TILE

COVER TILE

BOOSTER

BIRD STOP

END VIEW OF ABOVE

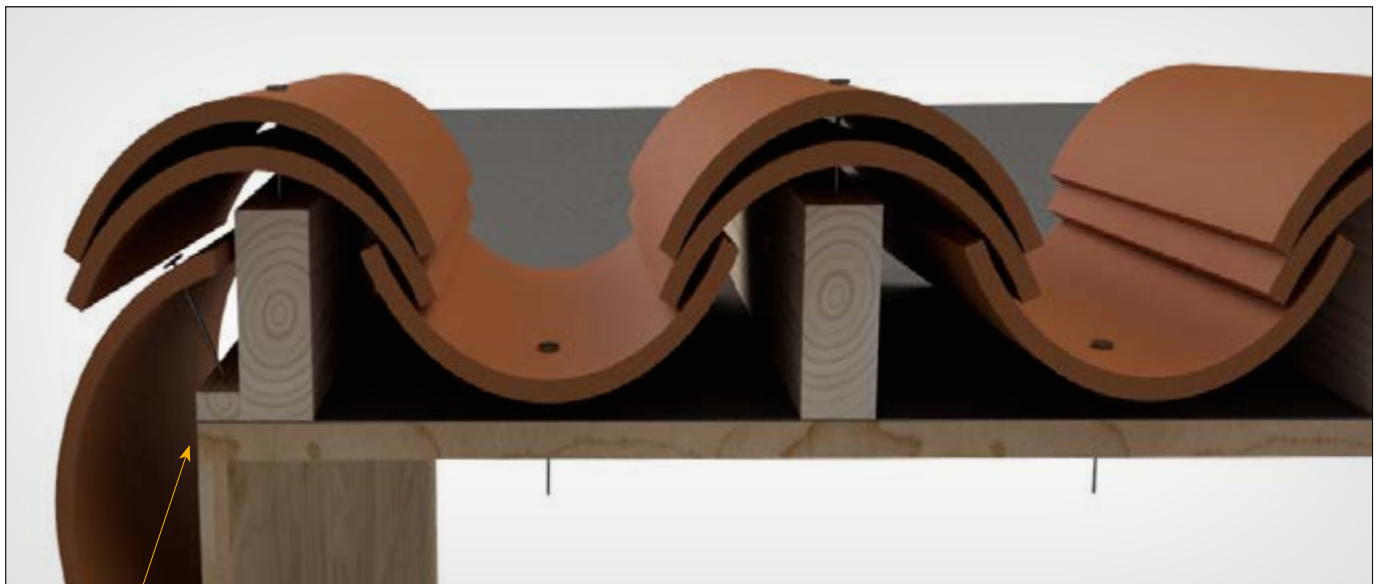

TURN UNDERLAYMENT DOWN 1"

Drawing shown depicts the application of all tile profiles. Unless otherwise noted, it would apply to either concrete or clay tiles.

MC-28

SPECIALTY INSTALLATIONS**Turret & Cone Shaped Installations****WE OFTEN SEE A CONE ROOF OR CONICAL ROOF SHAPE IN OLD BUILDINGS AND TRADITIONAL DESIGN BUILDINGS. HOW DID THEY DESIGN AND BUILD THIS SHAPE OF ROOF?**

TRI listed a few concepts of “Cone Roof” or “Conical Roof” from our field experiences. TRI uses the “Cone Roof” name for explanation purposes.

Key Design Concepts—Architects or builders must consider the following key lists when designing cone roofs.

1. The base of the cone roof must be a true circle. The radius of the base cone roof has to be the same distance, and it has to be a true circle. You cannot make any oval base shape. If the base design is not a true circle, the roof slope distance changes and tiles cannot be installed on the same horizontal line. You can design different pie or angles of the cone roof. For example, you can make a 360-degree, 180-degree, 45-degree, or any angle as long as the tile can be installed at that angle.

2. The cone roof tile exposure and the field tiles exposure should be the same.

Keep the cone roof tiles’ exposure and the field tiles’ exposure the same, except near the tops’ last few courses. Near the tops’ courses, it may need an adjustment on the cone roof tiles’ exposure depending on the size of the cone roof. Keeping the same exposure is essential to a distance appearance of point of view. When you use One Piece S tile for field tile sections, you can use Two Piece Mission Tile for the cone roof section as long as Two-Pieces and One-Piece S tiles are the same width and vertical exposure, and have a close size of the crown shape at the eave line. You do not have to use the entire roof with the Two-Piece mission tile.

3. It requires a metal cap or finial to cover the top of the cone roof. The roof tile cannot be a line, and it must have a minimum of 2" (5 cm) base triangles. Cone tile can reach close to the top of the roof; however, it needs to be covered with a metal cap or finial at least 12" (31 cm) distance from the top. The metal cap or finial must use the same roof pitch and add thickness of tile from the roof deck to fit and co the top.

4. A sealed underlayment roof is required. The cone roof tile is decorative. Depending on the size of the cone roof, you can use regular field tile at the beginning of a few courses; however, after a few courses, you need to modify tiles to fit the cone roof shape. The cone roof requires a sealed underlayment to protect against any water leaks.

Also, the cone roof must be covered with a cap sheet to protect it from UV. The cone roof tile is strictly a decorative roof.

5. How to order Pre-cut cone roof tiles. Some tile manufacturers offer pre-cut cone shape roof tiles. To order the pre-cut cone roof tiles, the roofing contractor must send the following information to the manufacturer.

- a. Architectural scaler roof drawing with elevation drawing and the field tile color

Or

- b. Provide roof pitch, angle of the pie shape, diameter or radius of the base cone roof, the number of cone roofs, and the field tile color

The roof tile manufacturer will provide a worksheet before you order the tiles and you should be able to double-check this worksheet. You can proceed with the ordering process of the cone roof tiles through your vendor.

AWARENESS OF INSTALLATION OF CONE ROOF TILES

To bid on the job or install the cone roof tiles, the roofing contractor must be aware that each cone roof tile shape changes at each course depending on the size of the cone roof. Some manufacturers offer pre-cut cone roof tiles. You can contact the manufacturer whom you will use the field tiles from.

SPECIALTY INSTALLATIONS

MC-28A

Turret & Cone Shaped Installations

1. Flat tile cone roof—If the contractor does not use pre-cut cone roof tiles, the contractor must cut trapezoid shapes from field tiles to fit the cone roof at the job site. Avoid any open gaps between tiles. Please be aware that cutting trapezoid shapes is not easy and also dangerous. You can re-start using a large size of trapezoid shape tiles near the top when tiles become too small to use. You must re-adjust the trapezoid angle to fit the cone roof. Installation of a flat cone roof is the same as shingle flat tiles. There is no side water channel.

2. Two Piece Mission Cone Roof Tile—A two-piece mission cone roof differs from a flat tile cone roof. Two-piece mission tiles width exposure can be adjusted up to a certain point. All two-piece cone shape roof top and pan tiles are the same as the top tiles. Install narrowed shape side toward the top of the roof. Standard two-piece field pan tiles have a nail hole at the wide side of the tile. But the top and pan tiles of the cone roof tile have a nail hole on the narrow side of the tiles. When cone tiles become less than 5" (12.9 cm) wide, the tile loses the crown shape and becomes a flat bar tile. Restart the field tile again on the next upper course; it loses the appearance of a cone roof and becomes a high punch list. Contact the Two-Piece Mission Tile manufacturer to get a smaller shape of the two-piece mission. Near the top roof, there is no space to install pan tiles. Install top tiles only to finish up the top section. If there is any gap between the tiles, fill the gap with mortar cement to protect the underlayment against UV.

3. The architectural drawing vs. the actual framework should have the same slope distance before installing the underlayment. Pre-cut cone roof tiles are all custom-made to fit the specified cone roof. The factory produces cone roof tiles with the provided architectural drawings. When the cone roof frame is complete, the roofing contractor must check the cone roof slope distance and the angle of the pie shape. If they find a different dimension, it is essential that the roofing contractor must request to fix the roof deck before installing the underlayment or notify the manufacturer to adjust the cone roof tiles. Otherwise, the cone roof tiles will not fit the specified cone roof.

4. Recommendation—Cutting many cone roof tiles at the job site is very dangerous to the worker. In any case, the contractor needs to cut the cone roof tiles; it is recommended to use a wet saw to cut tile on ground level to avoid tile-cutting dust all over the roof tile.

Usually, manufacturers produce pre-cut cone roof tiles during the raw material processes, and they do not cut tile from the finished field tiles. The benefit of using pre-cut cone roof tiles is that they will match the tile's exposure and color scheme with the field tile. Also, it will save many hours of labor and materials.

Please get in touch with TRI or the tile manufacturers for more detail.



Drawing shown depicts the application of all tile profiles. Unless otherwise noted, it would apply to either concrete or clay tiles.

MC-29

SPECIALTY INSTALLATIONS**Staggered Tile Installation**

STAGGERED INSTALLATION: Unlike standard installations, where battens are set to keep uniform coursing, a staggered installation requires battens to be set 1" closer together for each of the staggered courses for each inch of stagger.

1. Depending upon the pitch and of the roof and the nailing requirements, one tile is hung on the batten and the next tiles may be pulled up at random and nailed to the roof deck.
2. For each inch of stagger, you may need 10% more tiles and corresponding rake.
3. The sequence of the stagger should be determined prior to installation. Once established the tiles may be installed making sure all tiles have at minimum of a 3" headlap.
4. Where the tile channel (underlock) extends and exposed, it may be clipped to provide a more aesthetic looking roof.



Drawing shown depicts the application of all tile profiles. Unless otherwise noted, it would apply to either concrete or clay tiles.

APPENDIX B

ADHESIVE SECUREMENT SYSTEMS (WHEN USED AS AN ALTERNATIVE TO MECHANICAL FASTENING)

As an alternative to mechanical fastening of roof tiles, the use of foam adhesive securement systems that are approved by the authority having jurisdiction may be used.

The restrictions, if any, are found in the code approval or evaluation report and will address any special considerations for underlayment attachment climate restrictions and the required amount and placement of the foam adhesive materials to provide the code required uplift resistance when installed on direct deck and batten applications for concrete and clay tile.

When deciding to use foam adhesives for the securement of tile, consideration must be made on the compatibility of the adhesive to the underlayment surface. Although most code approved foam adhesives bond well to a variety of products like smooth or granulated underlayments, metal, concrete, clay, wood, etc., typically, they do not adhere to polyethylene or silicon surfaced products.

SOLAR MOUNTED SYSTEMS FOR ROOF TILE INSTALLATIONS THAT INCORPORATE SOLAR SYSTEMS

Consult with the manufacturer of the solar system and mounting attachments for additional requirements and limitations.

The roof must be constructed to support the loads of the roof-installed solar system. Roof-mounted or integrated systems that serve as roof coverings must conform to the requirements of Chapter 9 of the IRC, Chapter 15 of the IBC and/or other building, electrical, plumbing or other applicable codes. In addition, check with your local building official for specific licensing requirements.

Install solar systems incorporated into roof tile systems in accordance with the requirements of this Installation manual, solar systems manufacturer's installation guidelines and applicable building code requirements.

Appropriate flashing that properly directs and keeps water flow on the surface of the tile or redirects the flow via appropriate flashing onto the surface of the tile or off the roof is critical. Deck-mounted or other systems that penetrate the tile or roof deck shall have both primary roof tile flashing and secondary deck flashing.

Design wind speed calculation must be furnished from the solar manufacturer that meet or exceed local requirements, fire rating of the system verified if required and UL & CEC listing as required.

HIGH WIND APPLICATIONS

The following pages provide the information for installing concrete and clay roof tiles based upon the current ASCE-7-16 code requirements. For installations that were under previous versions, such as ASCE-7-10 or ASCE-7-05, please refer to our previous editions of the TRI Alliance installation manuals that can be downloaded from our website: tileroofing.org.

Drawing shown depicts the application of all tile profiles. Unless otherwise noted, it would apply to either concrete or clay tiles.

DESIGN CONSIDERATIONS FOR HIGH WIND APPLICATIONS UNDER THE ASCE-7-16 REQUIREMENTS

Please refer to the manufacturer's valid code approval for additional wind design details.

The installation requirements in the Table 5 series provide the normal installation guidelines for concrete and clay tile to comply with the Florida Building Code and International Building Code. The installation of tile in the specific regions of the country that are identified by FBC/IBC as subjected to wind speeds in excess of 110 miles per hour (V_{asd}), may be required to have additional fastening options not found in Table 3.

The Tile Roofing Industry Alliance (TRI) has derived various uplift resistance values for nail, screws and adhesive fastening systems on Plywood Sheathing. Some of these methods of installation may have limiting factors depending upon wind speed, roof slope and roof height. Please consult with your tile, underlayment and adhesive manufacturers or design professional for additional information about these optional systems for those unique installations.

The following design aids are provided to the roof designer for consideration in determining the required aerodynamic uplift moment for roof tiles for wind applications beyond the prescriptive requirements in the ICC/IRC.

These tables were developed based on the requirements of ASCE 7-16 for a tile factor of 1.407 ft^3 . The Tile Factor is determined from the following equation:

$TF = b * L * L_a (\text{ft}^3)$ where:

b = exposed width (ft)

L = roof tile length (ft)

$L_a = 0.76 * L$

Or use the tile factor ratio that provides the ratio of the actual tile to the $1.407 (\text{ft}^3)$ that some manufacturers have in their formal Product Approvals.

TABLE 4 (ASCE 7-16)

Conversion from Nominal Design Wind Speed to V_{asd} to Ultimate Design Wind Speed V_{ult} shall be converted as $V_{asd} = V_{ult} * 0.6$ or from the following table;

DESIGN WIND SPEED CONVERSION (MPH)									
V_{ULT}	110	120	130	140	150	160	170	180	190
V_{ASD}	85	93	101	108	116	124	132	139	147

For SI: 1 mile per hour = 0.44 m/s A linear interpolation is permitted.

DESIGN OF ATTACHMENT SYSTEM (EXAMPLES FOR ILLUSTRATIVE PURPOSES ONLY)

EXAMPLE 1

A building is a low-rise structure in an Exposure C region where the ultimate design wind speed is 190 mph. The building is a Category II structure. The mean height of the building is 40 feet. The roof is a gable roof with a roof slope of 7:12. The terrain around the building does not abruptly change so as to create any wind speedup effects due to channeling or shielding. The building is not located on a hill, ridge or escarpment that would cause the wind to speedup. The roof tiles will be flat/low profile concrete roof tiles with a total tile length of 17" and exposed width of 11.07". The roof tiles weigh 9 pounds each. The roof covering is installed direct to deck on solid sheathing.

Calculate the Required Aerodynamic Uplift Moment and use the Allowable Aerodynamic Uplift Resistance. Risk Category from (ASCE 7-16 Chapter 26.10-1):

Velocity pressure:

$$q_h = 0.00256 * K_z * K_{zt} * K_d * K_e * V^2$$

q_h = velocity pressure at height z (psf) V = Wind speed (V_{ult}) in MPH

Velocity Pressure, q_h (psf)									
Mean Roof height (ft)	Ultimate Design Wind Speed, V_{ult} (mph 3-second gust)								
	115	120	130	140	150	160	170	180	190
0-15	14.7	16.0	18.8	21.8	25.0	28.4	32.1	36.0	40.1
20	15.5	16.9	19.9	23.0	26.4	30.1	34.0	38.1	42.4
30	16.9	18.4	21.6	25.1	28.8	32.8	37.0	41.5	46.2
40	18.0	19.6	22.9	26.6	30.6	34.8	39.2	44.0	49.0
50	18.8	20.5	24.1	27.9	32.0	36.4	41.1	46.1	51.4
60	9.5	21.2	24.9	28.9	33.2	37.8	42.6	47.8	53.3

Note: The ultimate design wind speeds, V_{ult} , have been converted to nominal design wind speeds, V_{asd} , since roof tile attachments systems are based on test results.

K_e = ground elevation pressure (ASCE 7-16 Chapter 26.10-1)

$K_e = 1.0$ up to 1,000 ft.

K_z = velocity pressure exposure coefficient at height z (ASCE 7-16 Chapter 26.10-1) $K_z = 1.04$

K_{zt} = topographic factor: $K_{zt} = 1.0$ (ASCE 7-16 Chapter 26.8.2)

K_d = wind directionality factor: ($K_d = 0.85$) (ASCE 7-16 Chapter 26.6-1)

V_{ult} = basic wind speed (mph) Fig. 26.10-1 (190 mph)

$$q_h = 0.00256 * K_z * K_{zt} * K_d * K_e * V^2 = .00256 (1.04) (1.0) (0.85) (1.0) (190^2) = 48.9 \text{ psf}$$

From table left $q_h = 49.00$ psf

REQUIRED AERODYNAMIC MOMENT, M_a ; ALLOWABLE

Sample Calculations Aerodynamic Moment, M_a : Maximum Required Aerodynamic Uplift Moment, M_a (ft-lbf)

GCp For Roof Zones Gable 27° to 45° Wind area = 10 ft ²	
Zone 1	-1.8
Zone 2	-1.8
Zone 2n	-2.0
Zone 2r	-1.8
Zone 3e	-3.2
Zone 3r	-2.0

$$M_a = q_h CL b L La [1 - (GC_p)]$$

$$M_a = q_h CL b L La (1.0 - GC) = 49.0 \text{ psf} (0.2) (0.92') (1.42') (1.08') (1 - [-2.00]) = 41.4 \text{ ft-lbf}$$

From Table 12 MF, a proper fastening option will be selected that will meet the 41.4 ft-lbf

From Table for 27° to 45°	
q_h = Velocity Pressure at mean roof height h (psf)	$q_h = 49$ psf
CL = Lift Coefficient	CL = 0.2
b = Exposed width (ft)	$b = 0.92$
L = Roof tile length	L = 1.42 ft
La = Moment arm from axis of rotation to the point of uplift on the roof tile (ft)	$La = 0.76 L$ (ft)

Drawing shown depicts the application of all tile profiles. Unless otherwise noted, it would apply to either concrete or clay tiles.

**EXAMPLE 2**

The building in Example 2 is the same design requirements as found in Example 1 except the tile factor is now being calculated for a different tile dimension. For this example, a tile with an exposed width of 12" and a total tile length of 17" is being designed for installation.

In Example 1 we determined:

$$Ma = q_h CL b L La (1.0-GC) = 49.0 \text{ psf} (0.2)(0.92')(1.42')(1.08')(1 - [-2.00]) = 41.4 \text{ ft-lbf}$$

For this new tile dimension we will calculate the new Ma:

From Table for ° to °	
CL = Lift Coefficient	$q_h = 49 \text{ psf}$
b = Exposed width (ft)	CL = 0.2
L = Roof tile length	b = 0.92
La = Moment arm from axis of rotation to the point of uplift on the roof tile (ft)	L = 1.42 ft
$Ma = q_h CL b L La (1.0-GC) = 49.0 \text{ psf} (0.2)(1.0')(1.42')(1.08')(1 - [-2.00]) = 45.23 \text{ ft-lbf}$	

From Table 5 MF, a proper fastening option will be selected that will meet the 45.2 ft-lbf

FOR ASCE 7-16 WIND DESIGNS, THE FOLLOWING ROOF ZONE FIGURES ARE INCLUDED AS A REFERENCE TO THE TABLE CALCULATIONS

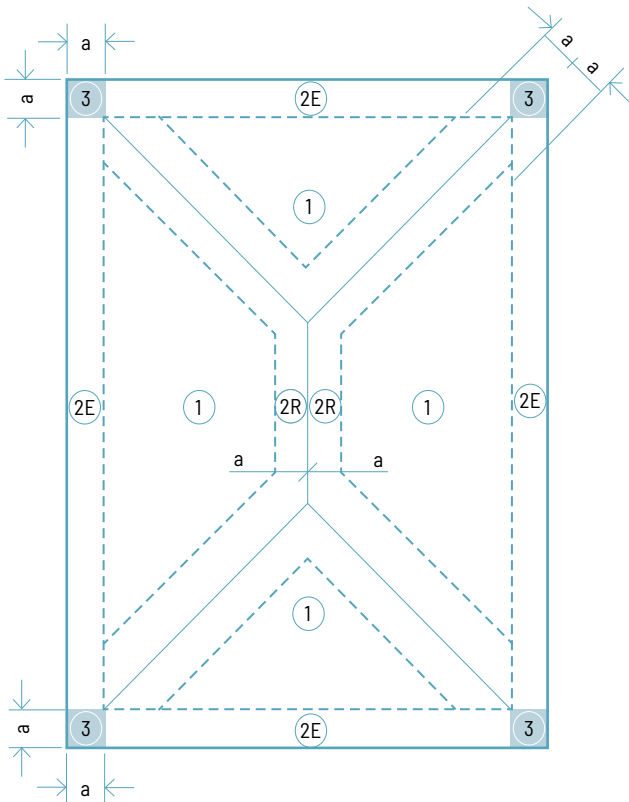

Figure 1.0 Hip Roof Zone Designation

■ = HIGH PRESSURE ZONES = 3
 OTHER = LOW PRESSURE ZONES = 1, 2E, 2R

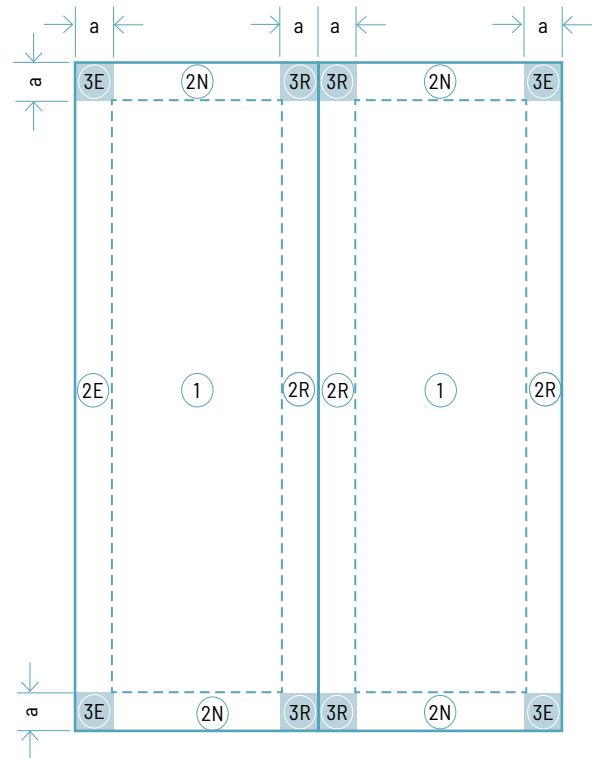
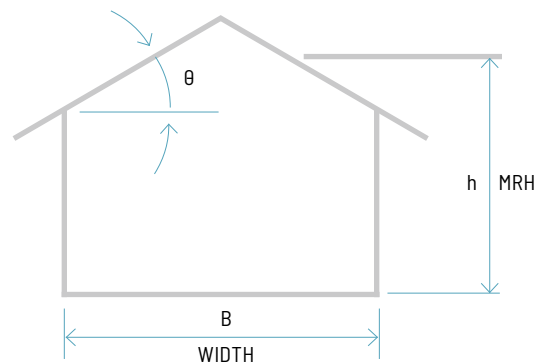
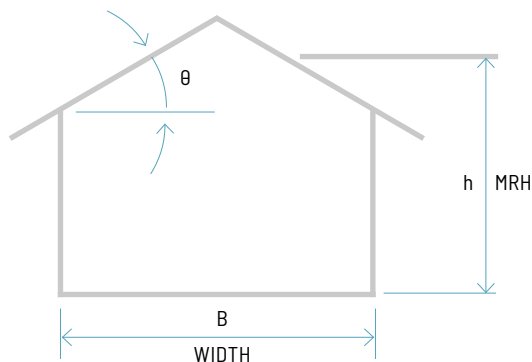

Figure 2.0 Gable Roof Zone Designation

■ = HIGH PRESSURE ZONES = 3E & 3R
 OTHER = LOW PRESSURE ZONES = 1, 2E, 2R & 2N



- a = 10% OF LEAST HORIZONTAL DIMENSION OR 0.4H, WHICHEVER IS SMALLER, BUT NOT LESS THAN EITHER 4% OF LEAST HORIZONTAL DIMENSION OR 3 FT (0.9 M).
- B = HORIZONTAL DIMENSION OF THE BUILDING IN FEET.
- h = MEAN ROOF EIGHT (MRH) IN FEET (EAVE HEIGHT PLUS RIDGE HEIGHT DIVIDED BY 2)
- θ = ANGLE OF ROOF PLANE FROM HORIZONTAL IN DEGREES (SLOPE OR PITCH).

Drawing shown depicts the application of all tile profiles. Unless otherwise noted, it would apply to either concrete or clay tiles.

TABLE 5 HB**Hip Roof - ASCE 7-16 - Wind speed (V_{ult}) in MPH****Exposure B - Tile Factor = 1.407 ft³**

ROOF SLOPES	MEAN ROOF HEIGHT (FT)	ROOF ZONES	115	120	130	140	150	160	170	180	190	
			Ma (FT-LBF)	Ma (FT-LBF)	Ma (FT-LBF)	Ma (FT-LBF)	Ma (FT-LBF)	Ma (FT-LBF)	Ma (FT-LBF)	Ma (FT-LBF)	Ma (FT-LBF)	
LESS THAN 4.5:12	0-30	LPZ	12.2	13.3	15.6	18.1	20.8	23.7	26.8	30.0	33.4	
		HPZ	12.2	13.3	15.6	18.1	20.8	23.7	26.8	30.0	33.4	
	40	LPZ	13.3	14.5	17.0	19.7	22.6	25.7	29.1	32.6	36.3	
		HPZ	13.3	14.5	17.0	19.7	22.6	25.7	29.1	32.6	36.3	
	50	LPZ	14.2	15.4	18.1	21.0	24.1	27.4	31.0	34.7	38.7	
		HPZ	14.2	15.4	18.1	21.0	24.1	27.4	31.0	34.7	38.7	
	60	LPZ	14.9	16.2	19.0	22.0	25.3	28.8	32.5	36.4	40.6	
		HPZ	14.9	16.2	19.0	22.0	25.3	28.8	32.5	36.4	40.6	
	4.5:12 TO LESS THAN 6:12	0-30	LPZ	10.2	11.1	13.0	15.1	17.4	19.8	22.3	25.0	27.9
			HPZ	10.2	11.1	13.0	15.1	17.4	19.8	22.3	25.0	27.9
		40	LPZ	11.1	12.1	14.2	16.4	18.8	21.4	24.2	27.1	30.2
			HPZ	11.1	12.1	14.2	16.4	18.8	21.4	24.2	27.1	30.2
50		LPZ	11.8	12.9	15.1	17.5	20.1	22.9	25.8	28.9	32.2	
		HPZ	11.8	12.9	15.1	17.5	20.1	22.9	25.8	28.9	32.2	
60		LPZ	12.4	13.5	15.8	18.4	21.1	24.0	27.1	30.4	33.8	
		HPZ	12.4	13.5	15.8	18.4	21.1	24.0	27.1	30.4	33.8	
6:12 TO 12:12		0-30	LPZ	12.9	14.1	16.5	19.2	22.0	25.0	28.2	31.7	35.3
			HPZ	15.6	17.0	20.0	23.2	26.6	30.3	34.2	38.3	42.7
		40	LPZ	14.0	15.3	17.9	20.8	23.9	27.2	30.7	34.4	38.3
			HPZ	17.0	18.5	21.7	25.2	28.9	32.9	37.1	41.6	46.4
	50	LPZ	15.0	16.3	19.1	22.2	25.4	29.0	32.7	36.6	40.8	
		HPZ	18.1	19.7	23.1	26.8	30.8	35.0	39.6	44.4	49.4	
	60	LPZ	15.7	17.1	20.1	23.3	26.7	30.4	34.3	38.5	42.8	
		HPZ	19.0	20.7	24.3	28.2	32.3	36.8	41.5	46.5	51.9	

Notes:

LPZ - Low Pressure Zones 1, 2e, & 2r for Hip Roofs, HPZ - High Pressure Zones 3 for Hip Roofs

 $h/B \leq 0.80$ values used where applicable (most conservative)Wind speed V_{ult} . Refer to tile manufacturer for additional information.

See Figure 1 on pg. 84 for additional details on on roof zone designations

Drawing shown depicts the application of all tile profiles. Unless otherwise noted, it would apply to either concrete or clay tiles.



TABLE 5 HC
Hip Roof – ASCE 7-16 - Wind Speed (V_{ult}) in MPH
Exposure C – Tile Factor = 1.407 ft³

ROOF SLOPES	MEAN ROOF HEIGHT (FT)	ROOF ZONES	115	120	130	140	150	160	170	180	190	
			Ma (FT-LBF)	Ma (FT-LBF)	Ma (FT-LBF)	Ma (FT-LBF)	Ma (FT-LBF)	Ma (FT-LBF)	Ma (FT-LBF)	Ma (FT-LBF)	Ma (FT-LBF)	Ma (FT-LBF)
LESS THAN 4.5:12	0-15	LPZ	14.9	16.1	19.0	22.0	25.3	28.8	32.5	36.4	40.6	
		HPZ	14.9	16.1	19.0	22.0	25.3	28.8	32.5	36.4	40.6	
	20	LPZ	15.7	17.1	20.1	23.3	26.8	30.5	34.4	38.6	43.0	
		HPZ	15.7	17.1	20.1	23.3	26.8	30.5	34.4	38.6	43.0	
	30	LPZ	17.1	18.7	21.9	25.4	29.2	33.2	37.5	42.0	46.8	
		HPZ	17.1	18.7	21.9	25.4	29.2	33.2	37.5	42.0	46.8	
	40	LPZ	18.2	19.8	23.2	27.0	31.0	35.2	39.8	44.6	49.7	
		HPZ	18.2	19.8	23.2	27.0	31.0	35.2	39.8	44.6	49.7	
	50	LPZ	19.1	20.8	24.4	28.3	32.4	36.9	41.7	46.7	52.0	
		HPZ	19.1	20.8	24.4	28.3	32.4	36.9	41.7	46.7	52.0	
	60	LPZ	19.8	21.5	25.3	29.3	33.6	38.3	43.2	48.4	54.0	
		HPZ	19.8	21.5	25.3	29.3	33.6	38.3	43.2	48.4	54.0	
	4.5:12 TO LESS THAN 6:12	0-15	LPZ	12.4	13.5	15.8	18.4	21.1	24.0	27.1	30.4	33.8
			HPZ	12.4	13.5	15.8	18.4	21.1	24.0	27.1	30.4	33.8
20		LPZ	13.1	14.3	16.8	19.4	22.3	25.4	28.7	32.1	35.8	
		HPZ	13.1	14.3	16.8	19.4	22.3	25.4	28.7	32.1	35.8	
30		LPZ	14.3	15.6	18.3	21.2	24.3	27.7	31.2	35.0	39.0	
		HPZ	14.3	15.6	18.3	21.2	24.3	27.7	31.2	35.0	39.0	
40		LPZ	15.2	16.5	19.4	22.5	25.8	29.3	33.1	37.1	41.4	
		HPZ	15.2	16.5	19.4	22.5	25.8	29.3	33.1	37.1	41.4	
50		LPZ	15.9	17.3	20.3	23.5	27.0	30.8	34.7	38.9	43.4	
		HPZ	15.9	17.3	20.3	23.5	27.0	30.8	34.7	38.9	43.4	
60		LPZ	16.5	17.9	21.0	24.4	28.0	31.9	36.0	40.4	45.0	
		HPZ	16.5	17.9	21.0	24.4	28.0	31.9	36.0	40.4	45.0	
6:12 TO 12:12		0-15	LPZ	15.7	17.1	20.1	23.3	26.7	30.4	34.3	38.5	42.8
			HPZ	19.0	20.7	24.3	28.2	32.3	36.8	41.5	46.5	51.9
	20	LPZ	16.6	18.1	21.2	24.6	28.3	32.2	36.3	40.7	45.4	
		HPZ	20.1	21.9	25.7	29.8	34.2	38.9	44.0	49.3	54.9	
	30	LPZ	18.1	19.7	23.1	26.8	30.8	35.0	39.5	44.3	49.4	
		HPZ	21.9	23.9	28.0	32.5	37.3	42.4	47.9	53.7	59.8	
	40	LPZ	19.2	20.9	24.5	28.5	32.7	37.2	42.0	47.0	52.4	
		HPZ	23.2	25.3	29.7	34.5	39.5	45.0	50.8	56.9	63.5	
	50	LPZ	20.1	21.9	25.7	29.8	34.2	39.0	44.0	49.3	54.9	
		HPZ	24.2	26.5	31.1	36.1	41.4	47.2	53.2	59.7	66.5	
	60	LPZ	20.9	22.7	26.7	30.9	35.5	40.4	45.6	51.1	57.0	
		HPZ	25.3	27.5	32.3	37.4	43.0	48.9	55.2	61.9	68.9	

Notes: See Table 5HB

Drawing shown depicts the application of all tile profiles. Unless otherwise noted, it would apply to either concrete or clay tiles.



TABLE 5 HD

Hip Roof - ASCE 7-16 - Wind Speed (V_{ult}) in MPH

Exposure D - Tile Factor = 1.407 ft³

ROOF SLOPES	MEAN ROOF HEIGHT (FT)	ROOF ZONES	115	120	130	140	150	160	170	180	190	
			Ma (FT-LBF)	Ma (FT-LBF)	Ma (FT-LBF)	Ma (FT-LBF)	Ma (FT-LBF)	Ma (FT-LBF)	Ma (FT-LBF)	Ma (FT-LBF)	Ma (FT-LBF)	Ma (FT-LBF)
LESS THAN 4.5:12	0-15	LPZ	18.0	19.6	23.0	26.7	30.7	34.9	39.4	44.1	49.2	
		HPZ	18.0	19.6	23.0	26.7	30.7	34.9	39.4	44.1	49.2	
	20	LPZ	18.9	20.6	24.1	28.0	32.1	36.6	41.3	46.3	51.6	
		HPZ	18.9	20.6	24.1	28.0	32.1	36.6	41.3	46.3	51.6	
	30	LPZ	20.3	22.1	25.9	30.1	34.5	39.3	44.3	49.7	55.4	
		HPZ	20.3	22.1	25.9	30.1	34.5	39.3	44.3	49.1	55.4	
	40	LPZ	21.3	23.2	27.3	31.6	36.3	41.3	46.6	52.3	58.3	
		HPZ	21.3	23.2	27.3	31.6	36.3	41.3	46.6	52.3	58.3	
	50	LPZ	22.2	24.2	28.4	32.9	37.8	43.0	48.5	54.4	60.6	
		HPZ	22.2	24.2	28.4	32.9	37.8	43.0	48.5	54.4	60.6	
	60	LPZ	22.9	25.0	29.3	34.0	39.0	44.4	50.1	56.1	62.6	
		HPZ	22.9	25.0	29.3	34.0	39.0	44.4	50.1	56.1	62.6	
	4.5:12 TO LESS THAN 6:12	0-15	LPZ	15.0	16.3	19.2	22.3	25.5	29.1	32.8	36.5	41.0
			HPZ	15.0	16.3	19.2	22.3	25.5	29.1	32.8	36.8	41.0
20		LPZ	15.7	17.1	20.1	23.3	26.8	30.5	34.4	38.6	43.0	
		HPZ	15.7	17.1	20.1	23.3	26.8	30.5	34.4	38.6	43.0	
30		LPZ	16.9	18.4	21.6	25.1	28.8	32.7	37.0	41.4	46.2	
		HPZ	16.9	18.4	21.6	25.1	28.8	32.7	37.0	41.4	46.2	
40		LPZ	17.8	19.4	22.7	26.4	30.3	34.4	38.9	43.6	48.5	
		HPZ	17.8	19.4	22.7	26.4	30.3	34.4	38.9	43.6	48.5	
50		LPZ	18.5	20.2	23.7	27.4	31.5	35.8	40.5	45.4	50.5	
		HPZ	18.5	20.2	23.7	27.4	31.5	35.8	40.5	45.4	50.5	
60		LPZ	19.1	20.8	24.4	28.3	32.5	37.0	41.7	46.8	52.1	
		HPZ	19.1	20.8	24.4	28.3	32.5	37.0	41.7	46.8	52.1	
6:12 TO 12:12		0-15	LPZ	19.0	20.7	24.3	28.2	32.4	36.8	41.6	46.6	51.9
			HPZ	23.0	25.1	29.4	34.1	39.2	44.6	50.3	56.4	62.8
	20	LPZ	19.9	21.7	25.5	29.6	33.9	38.6	43.6	48.9	54.4	
		HPZ	24.1	26.3	30.8	35.8	41.1	46.7	52.8	59.1	65.9	
	30	LPZ	21.4	23.3	27.4	31.7	36.4	41.5	46.8	52.5	58.5	
		HPZ	25.9	28.2	33.1	38.4	44.1	50.2	56.7	63.5	70.8	
	40	LPZ	22.5	24.5	28.8	33.4	38.3	43.6	49.2	55.2	61.5	
		HPZ	27.3	29.7	34.8	40.4	46.4	52.8	59.6	66.8	74.4	
	50	LPZ	23.4	25.5	30.0	34.8	39.9	45.4	51.2	57.4	64.0	
		HPZ	28.4	30.9	36.3	42.1	48.3	54.9	62.0	69.5	77.5	
	60	LPZ	24.2	26.3	30.9	35.8	41.2	46.8	52.9	59.3	66.0	
		HPZ	29.3	31.9	37.4	43.4	49.8	56.7	64.0	71.7	79.9	

Notes: See Table 5HB

Drawing shown depicts the application of all tile profiles. Unless otherwise noted, it would apply to either concrete or clay tiles.



TABLE 5 GB
Gable Roof – ASCE 7-16

Exposure B – Tile Factor = 1.407 ft³ Wind Speed = V_{ult}

ROOF SLOPES	MEAN ROOF HEIGHT (FT)	ROOF ZONES	115	120	130	140	150	160	170	180	190	
			Ma (FT-LBF)	Ma (FT-LBF)	Ma (FT-LBF)	Ma (FT-LBF)	Ma (FT-LBF)	Ma (FT-LBF)	Ma (FT-LBF)	Ma (FT-LBF)	Ma (FT-LBF)	Ma (FT-LBF)
LESS THAN 4.5:12	0-15	LPZ	13.6	14.8	17.4	20.2	23.1	26.3	29.7	33.3	37.1	
		HPZ	15.6	17.0	20.0	23.2	26.6	30.3	34.2	38.3	42.7	
	20	LPZ	13.6	14.8	17.4	20.2	23.1	26.3	29.7	33.3	37.1	
		HPZ	15.6	17.0	20.0	23.2	26.6	30.3	34.2	38.3	42.7	
	30	LPZ	13.6	14.8	17.4	20.2	23.1	26.3	29.7	33.3	37.1	
		HPZ	15.6	17.0	20.0	23.2	26.6	30.3	34.2	38.3	42.7	
	40	LPZ	14.8	16.1	18.9	21.9	25.1	28.6	32.3	36.2	40.3	
		HPZ	17.0	18.5	21.7	25.2	28.9	32.9	37.1	41.6	46.4	
	50	LPZ	15.7	17.1	20.1	23.3	26.8	30.5	34.4	38.6	43.0	
		HPZ	18.1	19.7	23.1	26.8	30.8	35.0	39.6	44.4	49.4	
	60	LPZ	16.5	18.0	21.1	24.5	28.1	32.0	36.1	40.5	45.1	
		HPZ	19.0	20.7	24.3	28.2	32.3	36.8	41.5	46.5	51.9	
	4.5:12 TO LESS THAN 6:12	0-15	LPZ	11.9	13.0	15.2	17.6	20.3	23.0	26.0	29.2	32.5
			HPZ	15.6	17.0	20.0	23.2	26.6	30.3	34.2	38.3	42.7
20		LPZ	11.9	13.0	15.2	17.6	20.3	23.0	26.0	29.2	32.5	
		HPZ	15.6	17.0	20.0	23.2	26.6	30.3	34.2	38.3	42.7	
30		LPZ	11.9	13.0	15.2	17.6	20.3	23.0	26.0	29.2	32.5	
		HPZ	15.6	17.0	20.0	23.2	26.6	30.3	34.2	38.3	42.7	
40		LPZ	12.9	14.1	16.5	19.2	22.0	25.0	28.2	31.7	35.3	
		HPZ	17.0	18.5	21.7	25.2	28.9	32.9	37.1	41.6	46.4	
50		LPZ	13.8	15.0	17.6	20.4	23.4	26.7	30.1	33.7	37.6	
		HPZ	18.1	19.7	23.1	26.8	30.8	35.0	39.6	44.0	49.4	
60		LPZ	14.5	15.7	18.5	21.4	24.6	28.0	31.6	35.4	39.5	
		HPZ	19.0	20.7	24.3	28.2	32.3	36.8	41.5	46.5	51.9	
6:12 TO 12:12		0-15	LPZ	10.2	11.1	13.0	15.1	17.4	19.8	22.3	25.0	27.9
			HPZ	14.3	15.6	18.3	21.2	24.3	27.7	31.2	35.0	39.0
	20	LPZ	10.2	11.1	13.0	15.1	17.4	19.8	22.3	25.0	27.9	
		HPZ	14.3	15.6	18.3	21.2	24.3	27.7	31.2	35.0	39.0	
	30	LPZ	10.2	11.1	13.0	15.1	17.4	19.8	22.3	25.0	27.9	
		HPZ	14.3	15.6	18.3	21.2	24.3	27.7	31.2	35.0	39.0	
	40	LPZ	11.1	12.1	14.2	16.4	18.8	21.4	24.2	27.1	30.2	
		HPZ	15.5	16.9	19.8	23.0	26.4	30.0	33.9	38.0	42.3	
	50	LPZ	11.8	12.9	15.1	17.5	20.1	22.9	25.8	28.9	32.2	
		HPZ	16.5	18.0	21.1	24.5	28.1	32.0	36.1	40.5	45.1	
	60	LPZ	12.4	13.5	15.8	18.4	21.1	24.0	27.1	30.4	33.8	
		HPZ	17.3	18.9	22.2	25.7	29.5	33.6	37.9	42.5	47.4	

Notes: LPZ – Low Pressure Zones 1, 2e, & 2r for Gable Roofs
 HPZ = High Pressure Zones 3e & 3r for Gable Roofs
 Wind speed V_{ult}. Refer to tile manufacturer for additional information.
 See Figure 1 and 2 on pg. 84 for additional details on on roof zone designations

Drawing shown depicts the application of all tile profiles. Unless otherwise noted, it would apply to either concrete or clay tiles.



TABLE 5 GC

Gable Roof - ASCE 7-16

Exposure C - Tile Factor = 1.407 ft³ Wind Speed = V_{ult}

ROOF SLOPES	MEAN ROOF HEIGHT (FT)	ROOF ZONES	115	120	130	140	150	160	170	180	190	
			Ma (FT-LBF)	Ma (FT-LBF)	Ma (FT-LBF)	Ma (FT-LBF)	Ma (FT-LBF)	Ma (FT-LBF)	Ma (FT-LBF)	Ma (FT-LBF)	Ma (FT-LBF)	Ma (FT-LBF)
LESS THAN 4.5:12	0-15	LPZ	16.5	18.0	21.1	24.5	28.1	32.0	36.1	40.5	45.1	
		HPZ	19.0	20.7	24.3	28.2	32.3	36.8	41.5	46.5	51.9	
	20	LPZ	17.5	19.0	22.4	25.9	29.8	33.9	38.2	42.9	47.7	
		HPZ	20.1	21.9	25.7	29.8	34.2	38.9	44.0	49.3	54.9	
	30	LPZ	19.0	29.7	24.3	28.2	32.4	36.9	41.6	46.7	52.0	
		HPZ	21.9	23.9	28.0	32.5	37.3	42.4	47.9	53.7	59.8	
	40	LPZ	20.2	22.0	25.8	30.0	34.4	39.1	44.2	49.5	55.2	
		HPZ	23.2	25.3	29.7	34.5	39.5	45.0	50.8	56.9	63.5	
	50	LPZ	21.2	23.1	27.1	31.4	36.0	41.0	46.3	51.9	57.8	
		HPZ	24.4	26.5	31.1	36.1	41.4	47.2	53.2	59.7	66.5	
	60	LPZ	22.0	23.9	28.1	32.5	37.4	42.5	48.0	53.8	60.0	
		HPZ	25.3	27.5	32.3	37.4	43.0	48.9	55.2	61.9	68.9	
	4.5:12 TO LESS THAN 6:12	0-15	LPZ	14.5	15.7	18.5	21.4	24.6	28.0	31.6	35.4	39.5
			HPZ	19.0	20.7	24.3	28.2	32.3	36.8	41.5	46.5	51.9
20		LPZ	15.3	16.7	19.6	22.7	26.0	29.6	33.4	37.5	41.8	
		HPZ	20.1	21.9	25.7	29.8	34.2	38.9	44.0	49.3	54.9	
30		LPZ	16.7	18.1	21.3	24.7	28.4	32.3	36.4	40.8	45.5	
		HPZ	21.9	23.9	28.0	32.5	37.3	42.4	47.9	53.7	59.8	
40		LPZ	17.7	19.3	22.6	26.2	30.1	34.2	38.7	43.3	48.3	
		HPZ	23.2	25.3	29.7	34.5	39.5	45.0	50.8	56.9	63.5	
50		LPZ	18.5	20.2	23.7	27.5	31.5	35.9	40.5	45.4	50.6	
		HPZ	24.4	26.5	31.1	36.1	41.4	47.2	53.2	59.7	66.5	
60		LPZ	19.2	20.9	24.6	28.5	32.7	37.2	42.0	47.1	52.5	
		HPZ	25.3	27.5	32.3	37.4	43.0	48.9	55.2	61.9	68.9	
6:12 TO 12:12		0-15	LPZ	12.4	13.5	15.8	18.4	21.1	24.0	27.1	30.4	33.8
			HPZ	17.3	18.9	22.2	25.7	29.5	33.6	37.9	42.5	47.4
	20	LPZ	12.2	13.3	15.6	18.1	20.8	23.7	26.8	30.0	33.4	
		HPZ	18.4	20.0	23.5	27.2	31.2	35.6	40.1	45.0	50.1	
	30	LPZ	14.3	15.6	18.3	21.2	24.3	27.7	31.2	35.0	39.0	
		HPZ	20.0	21.8	25.6	29.6	34.0	38.7	43.7	49.0	54.6	
	40	LPZ	15.2	16.5	19.4	22.5	25.8	29.3	33.1	37.1	41.4	
		HPZ	21.2	23.1	27.1	31.5	36.1	41.1	46.4	52.0	57.9	
	50	LPZ	15.9	17.3	20.3	23.5	27.0	30.8	34.7	38.9	43.4	
		HPZ	22.2	24.2	28.4	33.0	37.8	43.1	48.6	54.5	60.7	
	60	LPZ	16.5	17.9	21.0	24.4	28.0	31.9	36.0	40.4	45.0	
		HPZ	23.1	25.1	29.5	34.2	39.2	44.6	50.4	56.5	62.9	

Notes: See Table 5GB

Drawing shown depicts the application of all tile profiles. Unless otherwise noted, it would apply to either concrete or clay tiles.



TABLE 5 GD

Gable Roof – ASCE 7-16

Exposure D – Tile Factor = 1.407 ft³ Wind Speed = V_{ult}

ROOF SLOPES	MEAN ROOF HEIGHT (FT)	ROOF ZONES	115	120	130	140	150	160	170	180	190	
			Ma (FT-LBF)	Ma (FT-LBF)	Ma (FT-LBF)	Ma (FT-LBF)	Ma (FT-LBF)	Ma (FT-LBF)	Ma (FT-LBF)	Ma (FT-LBF)	Ma (FT-LBF)	Ma (FT-LBF)
LESS THAN 4.5:12	0-15	LPZ	20.0	21.8	25.6	29.7	34.1	38.8	43.7	49.0	54.6	
		HPZ	23.0	25.1	29.4	34.1	39.2	44.6	50.3	56.4	62.8	
	20	LPZ	21.0	22.9	26.8	31.1	35.7	40.6	45.9	51.4	57.3	
		HPZ	24.1	26.3	30.8	35.8	41.1	46.7	52.8	59.1	65.9	
	30	LPZ	22.5	24.5	28.8	33.4	38.4	43.6	49.3	55.2	61.5	
		HPZ	25.9	28.2	33.1	38.4	44.1	50.2	56.7	63.5	70.8	
	40	LPZ	23.7	25.8	30.3	35.1	40.3	45.9	51.8	58.1	64.7	
		HPZ	27.3	29.7	34.8	40.4	46.4	52.8	59.6	66.8	74.4	
	50	LPZ	24.7	26.9	31.5	36.6	42.0	47.8	53.9	60.5	67.4	
		HPZ	28.4	30.9	36.3	42.1	48.3	54.9	62.0	69.5	77.5	
	60	LPZ	25.5	27.7	32.5	37.7	43.3	49.3	55.6	62.4	69.5	
		HPZ	29.3	31.9	37.4	43.4	49.8	56.7	64.0	71.7	79.9	
	4.5:12 TO LESS THAN 6:12	0-15	LPZ	17.5	19.1	22.4	26.0	29.8	33.9	38.3	42.9	47.8
			HPZ	23.0	25.1	29.4	34.1	39.2	44.6	50.3	56.4	62.8
20		LPZ	18.4	20.0	23.5	27.2	31.2	35.6	40.1	45.0	50.1	
		HPZ	24.1	26.3	30.8	35.8	41.1	46.7	52.8	59.1	65.9	
30		LPZ	19.7	21.5	25.2	29.2	33.6	38.2	43.1	48.3	53.9	
		HPZ	25.9	28.2	33.1	38.4	44.1	50.2	56.7	63.5	70.8	
40		LPZ	20.7	22.6	26.5	30.7	35.3	40.2	45.3	50.8	56.6	
		HPZ	27.3	29.7	34.8	40.4	46.4	52.8	59.6	66.8	74.4	
50		LPZ	21.6	23.5	27.6	32.0	36.7	41.8	47.2	52.9	59.0	
		HPZ	28.4	30.9	36.3	42.1	48.3	54.9	62.0	69.5	77.5	
60		LPZ	22.3	24.3	28.5	33.0	37.9	43.1	48.7	54.6	60.8	
		HPZ	29.3	31.9	37.4	43.4	49.8	56.7	64.0	71.7	79.9	
6:12 TO 12:12		0-15	LPZ	15.0	16.3	19.2	22.3	25.5	29.1	32.8	36.8	27.9
			HPZ	21.0	22.9	26.9	31.2	35.8	40.7	45.9	51.5	57.4
	20	LPZ	15.7	17.1	20.1	23.3	26.8	30.5	34.4	38.6	43.0	
		HPZ	22.0	24.0	28.2	32.7	37.5	42.7	48.2	54.0	60.2	
	30	LPZ	16.9	18.4	21.6	25.1	28.8	32.7	37.0	41.4	46.2	
		HPZ	23.7	25.8	30.3	35.1	40.3	45.8	51.7	58.0	64.6	
	40	LPZ	17.8	19.4	22.7	26.4	30.3	34.4	38.9	43.6	48.5	
		HPZ	24.9	27.1	31.8	36.9	42.4	48.2	54.4	61.0	68.0	
	50	LPZ	18.5	20.2	23.7	27.4	31.5	35.8	40.5	45.4	50.5	
		HPZ	25.9	28.2	33.1	38.4	44.1	50.2	56.6	63.5	70.7	
	60	LPZ	19.1	20.8	24.4	28.3	32.5	37.0	41.7	46.8	52.1	
		HPZ	26.7	29.1	34.2	39.6	45.5	51.8	58.4	65.5	73.0	

Notes: See Table 5GB

Drawing shown depicts the application of all tile profiles. Unless otherwise noted, it would apply to either concrete or clay tiles.

TABLE 5 MF (ASCE 7-16)**Mechanical Roof Tile Resistance Values (ft-lbf) For Tile**

Deck Thickness	Method	Fastener Type	Low	Medium	High
15/32"	Direct Deck	1- 10d smooth or screw shank snail, with clip	25.2	25.2	35.5
		2- 10d, smooth or screw shank nail, with clip	39.1	38.1	44.3
		2-10d ring shanked nail	29.1	36.1	28.6
		2- 10d ring shank nail, with headlap	50.3	43.0	33.1
	Batten	1- #8 Screw	39.1	33.2	28.7
		2- #8 Screw	50.2	55.5	51.3
19/32"	Direct Deck	1- 10d smooth or screw shank snail, with clip	27.5	27.5	29.4
		2- 10d, smooth or screw shank nail, with clip	37.6	37.6	47.2
	Batten	2- 10d ring shanked nail	34.6	36.4	26.8
		1- #8 Screw	25.6	30.1	25.5
		2- #8 Screw	36.1	41.9	37.1
19/32"	Direct Deck	2- 10d ring shanked nail	46.4	45.5	41.2

For mean roof heights over 60 ft, engineering calculations must be submitted for permitting.

Notes for Table 5 MF:

- For attachment systems not listed in the table for 19/32" sheathing use the allowable aerodynamic uplift resistance from the table for 15/32" sheathing.
- Fasteners shall have a minimum edge distance of 1½ inches from the head of the tile and located in the pan of the tile to obtain the values in Table 5 MF. Consult the tile manufacturer for additional limitations or restrictions.
- Ring shank nails shall be 10d ring shank corrosion resistant steel nails with the following minimum dimensions: (3 inches long, 0.283 inch flat head diameter, 0.120 inch undeformed shank diameter or 0.131 inch screw diameter).
- Smooth or screw shank nails shall be 10d corrosion resistant steel (with the following minimum dimension. 3 inch long, 0.283 inch flat head diameter, 0.120 inch undeformed shank diameter or 0.131 inch screw diameter).
- Screws are #8 course threaded, 2.5 inches long corrosion-resistant steel wood screws conforming to ANSI/ASME B 18.6.1.
- The fastener hole nearest the overlock shall be used when a single nail or screw is required. The fastener hole nearest the underlock and the fastener hole nearest the overlock shall be used when two nails or screws are required.
- When using eave and field clips, attachment of the tiles is accomplished by a combination of nails and clips. Tiles are nailed to the sheathing or through the battens to the sheathing with one or two 10d corrosion resistant nails (Note 2 and 3 above) as required by Tables 5 and 6. Additionally, each tile is secured with a 0.060 inch thick and 0.5 inch wide clip which is secured to the plywood sheathing or eave fascia, as appropriate, with a single nail per clip. The nail shall be placed in the hole closest to the tile for clips having more than one nail hole. The following clip/nail combinations are permitted:
 - Aluminum alloy clip with 1.25 inch HD galvanized roofing nail (0.128 inch shank diameter).
 - Galvanized steel deck clip with 1.25 inch HD galvanized roofing nail (0.128 inch shank diameter).
 - Stainless steel clip with 1.25 inch HD galvanized roofing nail (0.128 inch shank diameter).
- Field clips and eave clips are to be located along the tile where the clip's preformed height and the tile's height above the underlayment are identical.
- Counter batten values not included.
- For attachment systems not listed in table for 15/32" sheathing, use allowable aerodynamic uplift moment from table for 15/32" sheathing.
- The allowable aerodynamic uplift moments include a generic restoring gravity moment of 6.5 ft-lbf for a direct deck installation and a generic restoring gravity moment of 5.5 ft-lbf for a batten installation.

Drawing shown depicts the application of all tile profiles. Unless otherwise noted, it would apply to either concrete or clay tiles.

DESIGN CONSIDERATIONS FOR HIGH WIND APPLICATIONS UNDER THE ASCE 7-22 REQUIREMENTS

Please refer to the manufacturer's valid code approval for additional wind design details.

The installation requirements in the Table 6 series provide the normal installation guidelines for concrete and clay tile to comply with the Florida Building Code and International Building Code. The installation of tile in the specific regions of the country that are identified by IBC as subjected to wind speeds in excess of 110 miles per hour (V_{asd}), may be required to have additional fastening options not found in Table 6.

The Tile Roofing Industry Alliance (TRI) has derived various uplift resistance values for nail, screws and adhesive fastening systems on Plywood Sheathing. Some of these methods of installation may have limiting factors depending upon wind speed, roof slope and roof height. Please consult with your tile, underlayment and adhesive manufacturers or design professional for additional information about these optional systems for those unique installations.

The following design aids are provided to the roof designer for consideration in determining the required aerodynamic uplift moment for roof tiles for wind applications beyond the prescriptive requirements in the FBC/IBC.

These tables were developed based on the requirements of ASCE 7-22 for a tile factor of 1.407 ft^3 . The Tile Factor is determined from the following equation:

$TF = b * L * La(\text{ft}^3)$ where:

b = exposed width (ft)

L = roof tile length (ft)

$La = 0.76 * L$

Or use the tile factor ratio that provides the ratio of the actual tile to the 1.407 ft^3 that some manufacturers have in their formal Product Approvals.

Conversion to Nominal Design Wind Speed V_{asd} from Ultimate Design Wind Speed V_{ult} shall be converted as $V_{asd} = V_{ult} * \sqrt{0.6}$ or from the following table; tables were calculated using V_{asd} .

For SI: 1 mile per hour = 0.44 m/s A linear interpolation is permitted.

Design Wind Speed Conversion (mph)									
V_{ult}	110	120	130	140	150	160	170	180	190
V_{asd}	85	93	101	108	116	124	132	139	147

Drawing shown depicts the application of all tile profiles. Unless otherwise noted, it would apply to either concrete or clay tiles.



EXAMPLE 1
DESIGN OF ATTACHMENT SYSTEM (EXAMPLE FOR ILLUSTRATIVE PURPOSES ONLY)

A building is a low-rise structure in an Exposure C region where the ultimate design wind speed is 170 mph. The building is a Category II structure. The mean height of the building is 40 feet. The roof is a gable roof with a roof slope of 7:12. The terrain around the building does not abruptly change so as to create any wind speedup effects due to channeling or shielding. The building is not located on a hill, ridge or escarpment that would cause the wind to speedup. The roof tiles will be flat/low profile concrete roof tiles with a total tile length of 17" and exposed width of 11.07". The roof tiles weigh 9 pounds each. The roof covering is installed direct to deck on solid sheathing.

Calculate the Required Aerodynamic Uplift Moment and use the Allowable Aerodynamic Uplift Resistance.

Risk Category from (ASCE 7-22 -Table 1.5-1D): Velocity pressure: $q_h = 0.00256 \cdot K_h \cdot K_{zt} \cdot K_e \cdot V^2$ q_h = velocity pressure at height z (psf)

Velocity Pressure, q_h (psf)									
Mean Roof Height (ft)	Exposure C								
	Ultimate Design Wind Speeds, V_{ult} (mph - 3-second gust)								
	115	120	130	140	150	160	170	180	190
0-15	17.3	18.8	22.1	25.2	29.4	33.4	37.7	42.3	47.1
20	18.3	19.9	23.4	27.1	31.1	35.4	40.0	44.8	49.9
30	19.9	21.7	25.4	29.5	33.9	38.5	43.5	48.8	54.3
40	21.1	23.0	27.0	31.3	35.9	40.9	46.9	51.8	57.7
50	22.1	24.1	28.3	32.8	37.7	42.9	48.4	54.2	60.4
60	23.0	25.0	29.3	34.0	39.1	44.4	50.2	56.2	62.7

Note: The ultimate design wind speeds, V^{ult} , have been converted to nominal design wind speeds, V_{asd} , since roof tile attachments systems are based on test results.

K_e = ground elevation pressure = (ASCE 7-22 Chapter 26.9)

K_e = 1.0 up to 1,000 ft.

K_{zt} = topographic factor: $K_{zt} = 1.0$ (ASCE 7-22 Chapter 26.8.2)

K_h = Velocity Pressure Coefficient (ASCE-7-22 10-2)

V = basic wind speed (mph) Fig. 26.5-1D (170 mph)

$q_h = 0.00256 \cdot K_h \cdot K_{zt} \cdot K_e \cdot V^2 = 0.00256 (1.04) (1.0) (170)^2 = 46.38 \text{ psf}$

From table left $q_h = 46.9 \text{ psf}$

REQUIRED AERODYNAMIC MOMENT, M_a ; ALLOWABLE

Sample Calculations Aerodynamic Moment, M_a :
Maximum Required Aerodynamic Uplift Moment, M_a (ft-lbf)

GCp for Roof Zones Gable 27° to 45° Wind Area = 10 ft ²	
Zone 1	-1.8
Zone 2	-2.0
Zone 3	-2.5

$M_a = q_h CL b L La [1-(GCp)]$

From Table for 27° to 45° Zone 3r GCp = -2.0	
q_h = Velocity pressure at mean roof height	$q_h = 46.9 \text{ psf}$
CL = Lift Coefficient	CL = 0.2
b = Exposed width (ft)	b = 0.92 ft
L = Roof Tile Length (ft)	L = 1.42 ft
La - Moment arm from the axis of rotation to the point of uplift on the roof tile (ft)	La = 0.76 ft

$M_a = q_h CL b L La (1-GCp) = 46.9 \text{ psf} (0.2) (0.92') (1.42') (1.08') (1-[-2.5]) = 42.89 \text{ ft-lbf}$
from Table 6 MF a proper fastening option will be selected that will meet the 42.89 ft-lbf

Drawing shown depicts the application of all tile profiles. Unless otherwise noted, it would apply to either concrete or clay tiles.

EXAMPLE 2

DESIGN OF ATTACHMENT SYSTEM (EXAMPLE FOR ILLUSTRATIVE PURPOSES ONLY)

The building in Example 2 is the same design requirements as found in Example 1 except the tile factor is now being calculated for a different tile dimension. For this example, a tile with an exposed width of 12" and a total tile length of 17" is being designed for installation.

In Example 1 we determined:

$$Ma = q_h CL b L La (1.0-GC) = 46.9 \text{ psf} (0.2)(0.92')(1.42')(1.08')(1 - [-2.5]) = 42.89 \text{ ft-lbf}$$

For this new tile dimension we will calculate the new Ma

CL = Lift coefficient	CL = 0.2
b = Exposed width (ft)	b = 1.0 ft
La = Roof tile length (ft)	L = 1.42ft
La = Moment arm from the axis of rotation to the point of uplift on the roof tile (ft)	La = 1.08 L (ft)

$$Ma = q_h CL b L La (1.0-GC) = 46.9 \text{ psf} (0.2)(1.0')(1.42')(1.08')(1 - [-2.5]) = 50.34 \text{ ft-lbf}$$

From Table 6MF, a proper fastening option will be selected that will meet the 50.34 ft-lbf

ASCE 7-22 WIND DESIGNS - ROOF ZONE AREAS

FIGURE 3.0 HIP ROOF ZONE DESIGNATION

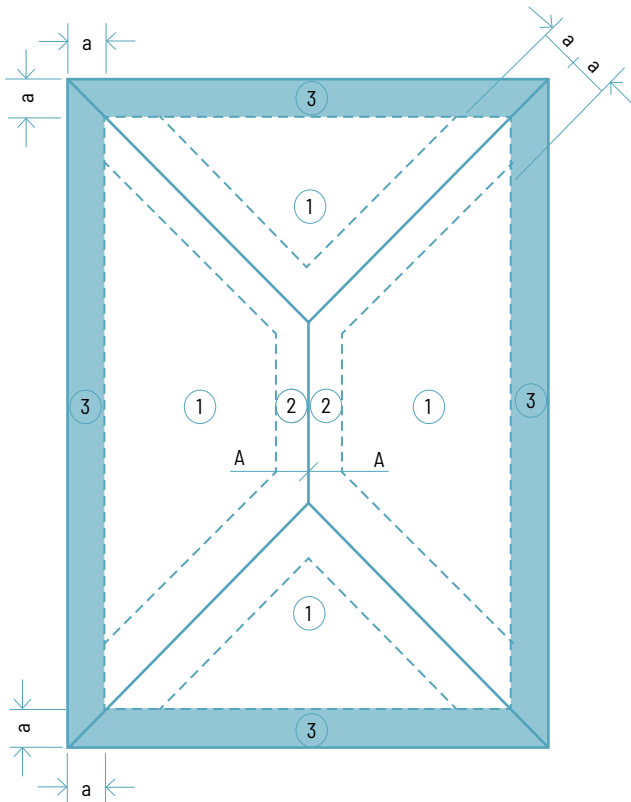

= PERIMETER ZONE 3

FIGURE 4.0 GABLE ROOF ZONE DESIGNATION

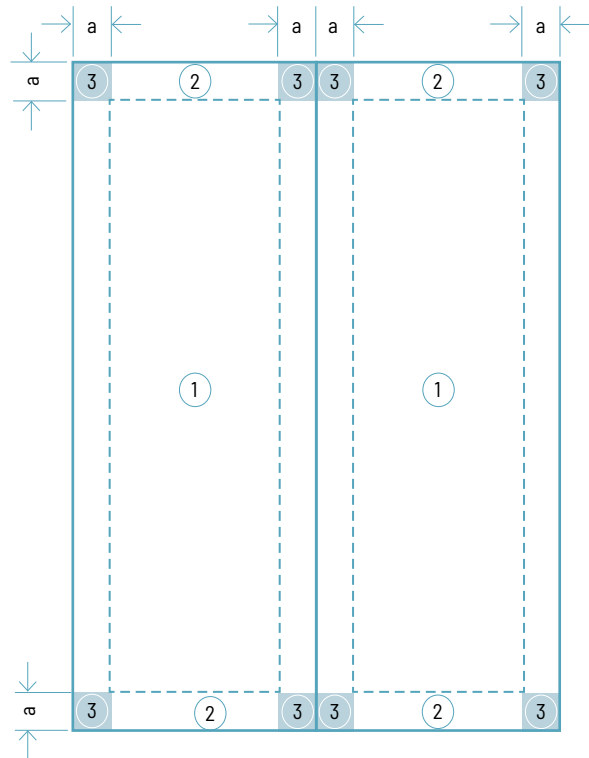

= PERIMETER ZONE 3

Appendix B

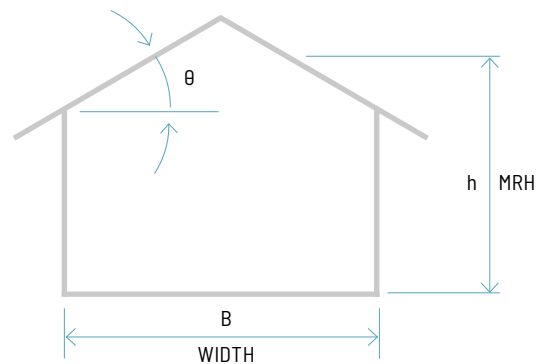
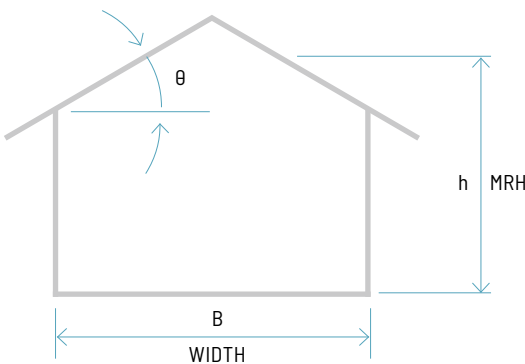

Notation:

a = 10% if least horizontal dimension or 0.4h, whichever is smaller, but not less than either 4% of least horizontal dimension or 3ft (0.9m). If an overhang exists, the edge shall be measured from the outside edge of the overhang. The horizontal dimensions used to compute the edge distance shall not include any overhang dimensions.

B = Horizontal dimension of building measured normal to wind direction, ft (m).

h = Mean roof height, in ft (m), except that eave height shall be used for $\theta \leq 10$ deg.

θ = Angle of plane of roof from horizontal, degrees.

Drawing shown depicts the application of all tile profiles. Unless otherwise noted, it would apply to either concrete or clay tiles.



TABLE 6 HB

Hip Roof – ASCE 7-22- Wind speed (V_{ult}) in MPH

Exposure B – Tile Factor = 1.407 ft³

Roof Slopes	Mean Roof Height (ft)	Roof Zones	115	120	130	140	150	160	170	180	190	
			Ma (ft-lbf)	Ma (ft-lbf)	Ma (ft-lbf)	Ma (ft-lbf)	Ma (ft-lbf)	Ma (ft-lbf)	Ma (ft-lbf)	Ma (ft-lbf)	Ma (ft-lbf)	Ma (ft-lbf)
Less than 4.5:12	0-30	LPZ	13.6	14.8	17.4	20.2	23.1	26.3	29.7	33.3	37.1	
		HPZ	14.4	15.7	18.4	21.3	24.5	27.9	31.5	35.3	39.3	
	40	LPZ	14.4	15.7	18.4	21.3	24.5	27.8	31.4	35.2	39.3	
		HPZ	15.2	16.6	19.5	22.6	25.9	29.5	33.3	37.3	41.6	
	50	LPZ	15.4	16.7	19.6	22.8	26.1	29.7	33.6	37.6	41.9	
		HPZ	16.3	17.7	20.8	24.1	27.7	31.5	35.5	39.8	44.4	
	60	LPZ	16.1	17.6	20.6	23.9	27.4	31.2	35.3	39.5	44.0	
		HPZ	17.1	18.6	21.8	25.3	29.1	33.1	37.3	41.8	46.6	
	4.5:12 to less than 6:12	0-30	LPZ	12.0	13.1	15.3	17.8	20.4	23.2	26.2	29.4	32.8
			HPZ	12.0	13.1	15.3	17.8	20.4	23.2	26.2	29.4	32.8
		40	LPZ	12.7	13.8	16.2	18.8	21.6	24.6	27.7	31.1	34.6
			HPZ	12.7	13.8	16.2	18.8	21.6	24.6	27.7	31.1	34.6
50		LPZ	13.5	14.8	17.3	20.1	23.0	26.2	29.6	33.2	37.0	
		HPZ	13.5	14.8	17.3	20.1	23.0	26.2	29.6	33.2	37.0	
60		LPZ	14.2	15.5	18.2	21.1	24.2	27.6	31.1	34.9	38.9	
		HPZ	14.2	15.5	18.2	21.1	24.2	27.6	31.1	34.9	38.9	
6:12 to 12:12		0-30	LPZ	11.2	12.2	14.3	16.6	19.1	21.7	24.5	27.4	30.6
			HPZ	13.6	14.8	17.4	20.2	23.1	26.3	29.7	33.3	37.1
	40	LPZ	11.8	12.9	15.1	17.6	20.2	22.9	25.9	29.0	32.3	
		HPZ	14.4	15.7	18.4	21.3	24.5	27.8	31.4	35.2	39.3	
	50	LPZ	12.6	13.8	16.2	18.7	21.5	24.5	27.6	31.0	34.5	
		HPZ	15.4	16.7	19.6	22.8	26.1	29.7	33.6	37.6	41.9	
	60	LPZ	13.3	14.5	17.0	19.7	22.6	25.7	29.0	32.5	36.3	
		HPZ	16.1	17.6	20.6	23.9	27.4	31.2	35.3	39.5	44.0	

LPZ – Low Pressure Zone 2 for Hip Roofs. HPZ – High Pressure Zone 3 for Hip Roofs.
 Wind speeds are V_{ult} . Refer to the tile manufacturer for additional information.
 See Figures 3.0 & 4.0 on page 96 for additional details on roof zone designations.

Drawing shown depicts the application of all tile profiles. Unless otherwise noted, it would apply to either concrete or clay tiles.



TABLE 6 HC

Hip Roof - ASCE 7-22 - Wind Speed (V_{ult}) in MPH

Exposure C - Tile Factor = 1.407 ft³

ROOF SLOPES	MEAN ROOF HEIGHT (FT)	ROOF ZONES	115	120	130	140	150	160	170	180	190
			Ma (FT-LBF)	Ma (FT-LBF)	Ma (FT-LBF)	Ma (FT-LBF)	Ma (FT-LBF)	Ma (FT-LBF)	Ma (FT-LBF)	Ma (FT-LBF)	Ma (FT-LBF)
LESS THAN 4.5:12	0-15	LPZ	16.5	18.0	21.1	24.5	28.1	32.0	36.1	40.5	45.1
		HPZ	17.5	19.0	22.4	25.9	29.8	33.9	38.2	42.9	47.7
	20	LPZ	17.5	19.0	22.4	25.9	29.8	33.9	38.2	42.9	47.7
		HPZ	18.5	20.2	23.7	27.4	31.5	35.9	40.5	45.4	50.6
	30	LPZ	19.0	20.7	24.3	28.2	32.4	36.9	41.6	46.7	52.0
		HPZ	20.2	22.0	25.8	29.9	34.3	39.0	44.1	49.4	55.1
	40	LPZ	20.2	22.0	25.8	30.0	34.4	39.1	44.2	49.5	55.2
		HPZ	21.4	23.3	27.4	31.7	36.4	41.4	46.8	52.4	58.4
	50	LPZ	21.2	23.1	27.1	31.4	36.0	41.0	46.3	51.9	57.8
		HPZ	22.4	24.4	28.7	33.2	38.2	43.4	49.0	55.0	61.2
	60	LPZ	22.0	23.9	28.1	32.5	37.4	42.5	48.0	53.8	60.0
		HPZ	23.3	25.3	29.7	34.5	39.6	45.0	50.8	57.0	63.5
4.5:12 TO LESS THAN 6:12	0-15	LPZ	14.6	15.9	18.6	21.6	24.8	28.2	31.9	35.7	39.8
		HPZ	14.6	15.9	18.6	21.6	24.8	28.2	31.9	35.7	39.8
	20	LPZ	15.4	16.8	19.7	22.9	26.3	29.9	33.7	37.8	42.1
		HPZ	15.4	16.8	19.7	22.9	26.3	29.9	33.7	37.8	42.1
	30	LPZ	16.8	18.3	21.5	24.9	28.6	32.5	36.7	41.2	45.9
		HPZ	16.8	18.3	21.5	24.9	28.6	32.5	36.7	41.2	45.9
	40	LPZ	17.8	19.4	22.8	26.4	30.3	34.5	39.0	43.7	48.7
		HPZ	17.8	19.4	22.8	26.4	30.3	34.5	39.0	43.7	48.7
	50	LPZ	18.7	21.1	23.9	27.7	31.8	36.2	40.8	45.8	51.0
		HPZ	18.7	21.1	23.9	27.7	31.8	36.2	40.8	45.8	51.0
	60	LPZ	19.4	21.1	24.8	28.7	33.0	37.5	42.3	47.5	52.9
		HPZ	19.4	21.1	24.8	28.7	33.0	37.5	42.3	47.5	52.9
6:12 TO 12:12	0-15	LPZ	13.6	14.8	17.4	20.2	23.1	26.3	29.7	33.3	37.1
		HPZ	16.5	18.0	21.1	24.5	28.1	32.0	36.1	40.5	45.1
	20	LPZ	14.4	15.7	18.4	21.3	24.5	27.9	31.5	35.3	39.3
		HPZ	17.5	19.0	22.4	25.9	29.8	33.9	38.2	42.9	47.7
	30	LPZ	15.7	17.1	20.0	23.2	26.7	30.4	34.3	38.4	42.8
		HPZ	19.0	20.7	24.3	28.2	32.4	36.9	41.6	46.7	52.0
	40	LPZ	16.6	18.1	21.3	24.7	28.3	32.2	36.4	40.8	45.4
		HPZ	20.2	22.0	25.8	30.0	34.4	39.1	44.2	49.5	55.2
	50	LPZ	17.4	19.0	22.3	25.9	29.7	33.8	38.1	42.7	47.6
		HPZ	21.2	23.1	27.1	31.4	36.0	41.0	46.3	51.9	57.8
	60	LPZ	18.1	19.7	23.1	26.8	30.8	35.0	39.5	44.3	47.6
		HPZ	22.0	23.9	28.1	32.5	37.4	42.5	48.0	53.8	57.8

LPZ - Low Pressure Zone 2 for Hip Roofs. HPZ - High Pressure Zone 3 for Hip Roofs.
 Wind speeds are V_{ult} . Refer to the tile manufacturer for additional information.
 See Figures 3.0 & 4.0 on page 96 for additional details on roof zone designations.

Drawing shown depicts the application of all tile profiles. Unless otherwise noted, it would apply to either concrete or clay tiles.



TABLE 6 HD
Hip Roof – ASCE 7-22 - Wind Speed (V_{ult}) in MPH
Exposure D – Tile Factor = 1.407 ft³

ROOF SLOPES	MEAN ROOF HEIGHT (FT)	ROOF ZONES	115	120	130	140	150	160	170	180	190	
			Ma (FT-LBF)	Ma (FT-LBF)	Ma (FT-LBF)	Ma (FT-LBF)	Ma (FT-LBF)	Ma (FT-LBF)	Ma (FT-LBF)	Ma (FT-LBF)	Ma (FT-LBF)	Ma (FT-LBF)
LESS THAN 4.5:12	0-15	LPZ	20.0	21.8	25.6	29.7	34.1	38.8	43.7	49.0	54.0	
		HPZ	21.2	23.1	27.1	31.4	36.1	41.0	46.3	51.9	57.9	
	20	LPZ	21.0	22.9	26.8	31.1	35.7	40.6	45.9	51.4	57.3	
		HPZ	21.0	22.9	26.8	31.1	35.7	40.6	45.9	51.4	57.3	
	30	LPZ	22.5	24.5	28.8	33.4	38.4	43.6	49.3	55.2	61.5	
		HPZ	23.9	26.0	30.5	35.4	40.6	46.2	52.2	58.5	65.2	
	40	LPZ	23.7	25.8	30.3	35.1	40.3	45.9	51.8	58.1	64.7	
		HPZ	25.1	27.3	32.1	37.2	42.7	48.6	54.9	61.5	68.5	
	50	LPZ	24.7	26.9	31.5	36.6	42.0	47.8	53.9	60.5	67.4	
		HPZ	26.1	28.5	33.4	38.7	44.5	50.6	57.1	64.0	71.3	
	60	LPZ	25.5	27.7	32.5	37.7	43.3	49.3	55.6	62.4	69.5	
		HPZ	27.0	29.4	34.5	40.0	45.9	52.2	58.9	66.0	73.6	
	4.5:12 TO LESS THAN 6:12	0-15	LPZ	17.7	19.2	22.6	26.2	30.1	34.2	38.6	43.3	48.2
			HPZ	17.7	19.2	22.6	26.2	30.1	34.2	38.6	43.3	48.2
20		LPZ	18.5	20.2	23.7	27.4	31.5	35.9	40.5	45.4	50.6	
		HPZ	18.5	20.2	23.7	27.4	31.5	35.9	40.5	45.4	50.6	
30		LPZ	19.9	21.7	25.4	29.5	33.8	38.5	43.5	48.7	54.3	
		HPZ	19.9	21.7	25.4	29.5	33.8	38.5	43.5	48.7	54.3	
40		LPZ	20.9	22.8	26.7	31.0	35.6	40.5	45.7	51.3	57.1	
		HPZ	20.9	22.8	26.7	31.0	35.6	40.5	45.7	51.3	57.1	
50		LPZ	21.8	23.7	27.8	32.3	37.1	42.2	47.6	53.4	59.5	
		HPZ	21.8	23.7	27.8	32.3	37.1	42.2	47.6	53.4	59.5	
60		LPZ	22.5	24.5	28.7	33.3	38.2	43.5	49.1	55.0	61.3	
		HPZ	22.5	24.5	28.7	33.3	38.2	43.5	49.1	55.0	61.3	
6:12 TO 12:12		0-15	LPZ	16.5	18.0	21.1	24.4	28.0	31.9	36.0	40.4	45.0
			HPZ	20.0	21.8	25.6	29.7	34.1	38.8	43.7	49.0	54.6
	20	LPZ	17.3	18.8	22.1	25.6	29.4	33.5	37.8	42.4	47.2	
		HPZ	21.0	22.9	26.8	31.1	35.7	40.6	45.9	51.4	57.3	
	30	LPZ	18.6	20.2	23.7	27.5	31.6	35.9	40.6	45.5	50.7	
		HPZ	22.5	24.5	28.8	33.4	38.4	43.6	49.3	55.2	61.5	
	40	LPZ	19.5	21.3	25.0	28.9	33.2	37.8	42.7	47.8	53.3	
		HPZ	23.7	25.8	30.3	35.1	40.3	45.9	51.8	58.1	64.7	
	50	LPZ	20.3	22.1	26.0	30.1	34.6	39.3	44.4	49.4	55.5	
		HPZ	24.7	26.9	31.5	36.6	42.0	47.8	53.9	60.5	67.4	
	60	LPZ	21.0	22.8	26.8	31.1	35.7	40.6	45.8	51.4	57.2	
		HPZ	25.5	27.7	32.5	37.7	43.3	49.3	55.6	62.4	69.5	

LPZ – Low Pressure Zone 2 for Hip Roofs. HPZ – High Pressure Zone 3 for Hip Roofs.
 Wind speeds are V_{ult} . Refer to the tile manufacturer for additional information.
 See Figures 3.0 & 4.0 on page 96 for additional details on roof zone designations.

Drawing shown depicts the application of all tile profiles. Unless otherwise noted, it would apply to either concrete or clay tiles.



TABLE 6 GB

Gable Roof - ASCE 7-22 - Wind Speed (V_{ult}) in MPH

Exposure B - Tile Factor = 1.407 ft³

ROOF SLOPES	MEAN ROOF HEIGHT (FT)	ROOF ZONES	115	120	130	140	150	160	170	180	190	
			Ma (FT-LBF)	Ma (FT-LBF)	Ma (FT-LBF)	Ma (FT-LBF)	Ma (FT-LBF)	Ma (FT-LBF)	Ma (FT-LBF)	Ma (FT-LBF)	Ma (FT-LBF)	
LESS THAN 4.5:12	0-15	LPZ	14.8	16.1	18.9	21.9	25.2	28.7	32.4	36.3	40.4	
		HPZ	18.4	20.0	23.5	27.3	31.3	35.6	40.2	45.1	50.2	
	20	LPZ	14.8	16.1	18.9	21.9	25.2	28.7	32.4	36.3	40.4	
		HPZ	18.4	20.0	23.5	27.3	31.3	35.6	40.2	45.1	50.2	
	30	LPZ	14.8	16.1	18.9	21.9	25.2	28.7	32.4	36.3	40.4	
		HPZ	18.4	20.0	23.5	27.3	31.3	35.6	40.2	45.1	50.2	
	40	LPZ	15.7	17.0	20.0	23.2	26.6	30.3	34.2	38.3	42.7	
		HPZ	19.5	21.2	24.9	28.8	33.1	37.7	42.5	47.7	53.1	
	50	LPZ	16.7	18.2	21.4	24.8	28.4	32.3	36.5	40.9	45.6	
		HPZ	20.8	22.6	26.5	30.8	35.3	40.2	45.4	50.9	56.7	
	60	LPZ	17.6	19.1	22.4	26.0	29.9	34.0	38.4	43.0	47.9	
		HPZ	21.8	23.8	27.9	32.3	37.1	42.2	47.7	53.5	59.6	
	4.5:12 TO LESS THAN 6:12	0-15	LPZ	17.0	18.5	21.7	25.2	28.9	32.9	37.2	41.7	46.4
			HPZ	19.4	21.2	24.8	28.8	33.1	37.6	42.5	47.6	53.1
20		LPZ	17.0	18.5	21.7	25.2	28.9	32.9	37.2	41.7	46.4	
		HPZ	19.4	21.2	24.8	28.8	33.1	37.6	42.5	47.6	53.1	
30		LPZ	17.0	18.5	21.7	25.2	28.9	32.9	37.2	41.7	46.4	
		HPZ	19.4	21.2	24.8	28.8	33.1	37.6	42.5	47.6	53.1	
40		LPZ	18.0	19.6	23.0	26.7	30.6	34.9	39.4	44.1	49.2	
		HPZ	20.6	22.4	26.3	30.5	35.0	39.8	45.0	50.4	56.2	
50		LPZ	18.8	20.5	24.0	27.9	32.0	36.4	41.1	46.1	51.3	
		HPZ	21.5	23.4	27.7	31.9	36.6	41.6	47.0	52.7	58.7	
60		LPZ	19.6	21.3	25.1	29.1	33.4	38.0	42.8	48.0	53.5	
		HPZ	22.4	24.4	28.6	33.2	38.1	43.4	49.0	54.9	61.2	
6:12 TO 12:12		0-15	LPZ	12.0	13.1	15.3	17.8	20.4	23.2	26.2	29.4	32.8
			HPZ	14.0	15.2	17.9	20.8	23.8	27.1	30.6	34.3	38.2
	20	LPZ	12.0	13.1	15.3	17.8	20.4	23.2	26.2	29.4	32.8	
		HPZ	14.0	15.2	17.9	20.8	23.8	27.1	30.6	34.3	38.2	
	30	LPZ	12.0	13.1	15.3	17.8	20.4	23.2	26.2	29.4	32.8	
		HPZ	14.0	15.2	17.9	20.8	23.8	27.1	30.6	34.3	38.2	
	40	LPZ	12.7	13.8	16.2	18.8	21.6	24.6	27.7	31.1	34.6	
		HPZ	14.8	16.1	18.9	21.9	25.2	28.7	32.4	36.3	40.4	
	50	LPZ	13.5	14.8	17.3	20.1	23.0	26.2	29.6	33.2	37.0	
		HPZ	15.8	17.2	20.2	23.4	26.9	30.6	34.5	38.7	43.1	
	60	LPZ	14.2	15.5	18.2	21.1	24.2	27.6	31.1	34.9	38.9	
		HPZ	16.6	18.1	21.2	24.6	28.3	32.1	36.3	40.7	45.3	

a = 10% of least horizontal dimension or 0.4h, whichever is smaller, but not less than either 4% of least horizontal dimension or 3 ft (0.9 m)

LPZ = Low Pressure Zone = 2 for Gable Roofs; HPZ = High Pressure Zone = 3 for Gable Roofs Refer to tile manufacturers for additional information on tile installation requirements

Drawing shown depicts the application of all tile profiles. Unless otherwise noted, it would apply to either concrete or clay tiles.



TABLE 6 GC
Gable Roof – ASCE 7-22 – Wind Speed (V_{ult}) in MPH
Exposure C – Tile Factor = 1.407 ft³

ROOF SLOPES	MEAN ROOF HEIGHT (FT)	ROOF ZONES	115	120	130	140	150	160	170	180	190	
			Ma (FT-LBF)	Ma (FT-LBF)	Ma (FT-LBF)	Ma (FT-LBF)	Ma (FT-LBF)	Ma (FT-LBF)	Ma (FT-LBF)	Ma (FT-LBF)	Ma (FT-LBF)	Ma (FT-LBF)
LESS THAN 4.5:12	0-15	LPZ	18.0	19.6	23.0	26.6	30.6	34.8	39.3	44.0	49.1	
		HPZ	22.4	24.3	28.6	33.1	38.0	43.3	48.8	54.8	61.0	
	20	LPZ	19.0	20.7	24.3	28.2	32.4	36.8	41.6	46.6	52.0	
		HPZ	23.7	25.8	30.2	35.1	40.3	45.8	51.7	58.0	64.6	
	30	LPZ	20.7	22.6	26.5	30.7	35.3	40.1	45.3	50.8	56.6	
		HPZ	25.8	28.1	32.9	38.2	43.8	49.9	56.3	63.1	70.3	
	40	LPZ	22.0	24.0	28.1	32.6	37.4	42.6	48.1	53.9	60.0	
		HPZ	27.3	29.8	34.9	40.5	46.5	52.9	59.8	67.0	74.7	
	50	LPZ	23.1	25.1	29.5	34.2	39.2	44.6	50.4	56.5	62.9	
		HPZ	28.7	31.2	36.6	42.5	48.8	55.5	62.6	70.2	78.2	
	60	LPZ	23.9	26.0	30.5	35.4	40.7	46.3	52.2	58.6	65.2	
		HPZ	29.7	32.4	38.0	44.0	50.6	57.5	64.9	72.8	81.1	
	4.5:12 TO LESS THAN 6:12	0-15	LPZ	17.0	18.5	21.7	25.2	28.9	32.9	37.2	41.7	46.4
			HPZ	19.4	21.2	24.8	28.8	33.1	37.6	42.5	47.6	53.1
20		LPZ	18.0	19.6	23.0	26.7	30.6	34.9	39.4	44.1	49.2	
		HPZ	20.6	22.4	26.3	30.5	35.0	39.8	45.0	50.4	56.2	
30		LPZ	19.6	21.3	25.1	29.1	33.4	38.0	42.8	48.0	53.5	
		HPZ	22.4	24.4	28.6	33.2	38.1	43.4	49.0	54.9	61.2	
40		LPZ	20.8	22.7	26.6	30.8	35.4	40.3	45.5	51.0	56.8	
		HPZ	23.8	25.9	30.4	35.2	40.5	46.0	52.0	58.3	64.9	
50		LPZ	21.8	23.7	27.9	32.3	37.1	42.2	47.7	53.4	59.5	
		HPZ	24.9	27.1	31.9	36.9	42.4	48.2	54.5	61.1	68.0	
60		LPZ	22.6	24.6	28.9	33.5	38.5	43.8	49.4	55.4	61.7	
		HPZ	25.8	28.1	33.0	38.3	44.0	50.0	56.5	63.3	70.5	
6:12 TO 12:12		0-15	LPZ	14.6	15.9	18.6	21.6	24.8	28.2	31.9	35.7	39.8
			HPZ	17.0	18.5	21.7	25.2	28.9	32.9	37.2	41.7	46.4
	20	LPZ	15.4	16.8	19.7	22.9	26.3	29.9	33.7	37.8	42.1	
		HPZ	18.0	19.6	23.0	26.7	30.6	34.9	39.4	44.1	49.2	
	30	LPZ	16.8	18.3	21.5	24.9	28.6	32.5	36.7	41.2	45.9	
		HPZ	19.6	21.3	25.1	29.1	33.4	38.0	42.8	48.0	53.5	
	40	LPZ	17.8	19.4	22.8	26.4	30.3	34.5	39.0	43.7	48.7	
		HPZ	20.8	22.7	26.6	30.8	35.4	40.3	45.5	51.0	56.8	
	50	LPZ	18.7	20.4	23.9	27.7	31.8	36.2	40.8	45.8	51.0	
		HPZ	21.8	23.7	27.9	32.3	37.1	42.2	47.7	53.4	59.5	
	60	LPZ	19.4	21.1	24.8	28.7	33.0	37.5	42.3	47.5	52.9	
		HPZ	22.6	24.6	28.9	33.5	38.5	43.8	49.4	55.4	61.7	

a = 10% of least horizontal dimension or 0.4h, whichever is smaller, but not less than either 4% of least horizontal dimension or 3 ft (0.9 m)
 LPZ = Low Pressure Zone = 2 for Gable Roofs; HPZ = High Pressure Zone = 3 for Gable Roofs Refer to tile manufacturers for additional information on tile installation requirements

Drawing shown depicts the application of all tile profiles. Unless otherwise noted, it would apply to either concrete or clay tiles.



TABLE 6 GD

Gable Roof - ASCE 7-22 - Wind Speed (V_{ult}) in MPH

Exposure D - Tile Factor = 1.407 ft³

ROOF SLOPES	MEAN ROOF HEIGHT (FT)	ROOF ZONES	115	120	130	140	150	160	170	180	190
			Ma (FT-LBF)	Ma (FT-LBF)	Ma (FT-LBF)	Ma (FT-LBF)	Ma (FT-LBF)	Ma (FT-LBF)	Ma (FT-LBF)	Ma (FT-LBF)	Ma (FT-LBF)
LESS THAN 4.5:12	0-15	LPZ	21.8	23.7	27.8	32.3	37.1	42.2	47.6	53.4	59.5
		HPZ	27.1	29.5	34.6	40.1	46.1	52.4	59.2	66.4	73.9
	20	LPZ	22.8	24.9	29.2	33.9	38.9	44.2	49.9	56.0	62.4
		HPZ	28.4	30.9	36.3	42.1	48.3	55.0	62.1	69.6	77.5
	30	LPZ	24.5	26.7	31.4	36.4	41.7	47.5	53.6	60.1	67.0
		HPZ	30.5	33.2	39.0	45.2	51.9	59.0	66.7	74.7	83.3
	40	LPZ	25.8	28.1	33.0	38.2	43.9	50.0	56.4	63.2	70.4
		HPZ	32.1	34.9	41.0	47.5	54.6	62.1	70.1	78.6	87.6
	50	LPZ	26.9	29.2	34.3	39.8	45.7	52.0	58.7	65.8	73.3
		HPZ	33.4	36.4	42.7	49.5	56.8	64.6	73.0	81.8	91.2
	60	LPZ	27.7	30.2	35.4	41.1	47.1	53.6	60.5	67.9	75.6
		HPZ	34.4	37.5	44.0	51.1	58.6	66.7	75.3	84.4	94.0
4.5:12 TO LESS THAN 6:12	0-15	LPZ	20.6	22.4	26.3	30.5	35.1	39.9	45.0	50.5	56.3
		HPZ	23.6	25.6	30.1	34.9	40.1	45.6	51.5	57.7	64.3
	20	LPZ	21.6	23.5	27.6	32.0	36.8	41.8	47.2	52.9	59.0
		HPZ	24.7	26.9	31.6	36.6	42.0	47.8	54.0	60.5	67.4
	30	LPZ	23.2	25.3	29.7	34.4	39.5	44.9	50.7	56.9	63.4
		HPZ	26.5	28.9	33.9	39.3	45.1	51.3	58.0	65.0	72.4
	40	LPZ	24.4	26.6	31.2	36.2	41.5	47.3	53.3	59.8	66.6
		HPZ	27.9	30.4	35.6	41.3	47.5	54.0	61.0	68.3	76.1
	50	LPZ	25.4	27.7	32.5	37.7	43.2	49.2	55.5	62.3	69.4
		HPZ	29.0	31.6	37.1	43.0	49.4	56.2	63.5	71.1	79.3
	60	LPZ	26.2	28.5	33.5	38.8	44.6	50.7	57.3	64.2	71.5
		HPZ	30.0	32.6	38.3	44.4	51.0	58.0	65.5	73.4	81.8
6:12 TO 12:12	0-15	LPZ	17.7	19.2	22.6	26.2	30.1	34.2	38.6	43.3	48.2
		HPZ	20.6	22.4	26.3	30.5	35.1	39.9	45.0	50.5	56.3
	20	LPZ	18.5	20.2	23.7	27.4	31.5	35.9	40.5	45.4	50.6
		HPZ	21.6	23.5	27.6	32.0	36.8	41.8	47.2	52.9	59.0
	30	LPZ	19.9	21.7	25.4	29.5	33.8	38.5	43.5	48.7	54.3
		HPZ	23.2	25.3	29.7	34.4	39.5	44.9	50.7	56.9	63.4
	40	LPZ	20.9	22.8	26.7	31.0	35.6	40.5	45.7	51.3	57.1
		HPZ	24.4	26.6	31.2	36.2	41.5	47.3	53.3	59.8	66.6
	50	LPZ	21.8	23.7	27.8	32.3	37.1	42.2	47.6	53.4	59.5
		HPZ	25.4	27.7	32.5	37.7	43.2	49.2	55.5	62.3	69.4
	60	LPZ	22.5	24.5	28.7	33.3	38.2	43.5	49.1	55.0	61.3
		HPZ	26.2	28.5	33.5	38.8	44.6	50.7	57.3	64.2	71.5

a = 10% of least horizontal dimension or 0.4h, whichever is smaller, but not less than either 4% of least horizontal dimension or 3 ft (0.9 m)

LPZ = Low Pressure Zone = 2 for Gable Roofs; HPZ = High Pressure Zone = 3 for Gable Roofs Refer to tile manufacturers for additional information on tile installation requirements

Drawing shown depicts the application of all tile profiles. Unless otherwise noted, it would apply to either concrete or clay tiles.

TABLE 6 MF (ASCE 7-22)
Mechanical Roof Tile Resistance Values (ft-lbf) For Tile

Deck Thickness	Method	Fastener Type	Low	Medium	High
15/32"	Direct Deck	1- 10d smooth or screw shank snail, with clip	25.2	25.2	35.5
		2- 10d, smooth or screw shank nail, with clip	38.1	38.1	44.3
		2-10d ring shanked nail	31.9	36.1	28.6
		2- 10d ring shank nail, with headlap	50.3	43.0	33.1
	Batten	1- #8 Screw	39.1	33.2	28.7
		2- #8 Screw	50.2	55.5	51.3
19/32"	Direct Deck	1- 10d smooth or screw shank snail, with clip	27.5	27.5	29.4
		2- 10d, smooth or screw shank nail, with clip	37.6	37.6	47.2
		2- 10d ring shanked nail	34.6	36.4	26.8
		1- #8 Screw	25.6	30.1	25.5
	2- #8 Screw	36.1	41.9	37.1	
	2- 10d ring shanked nail	46.4	45.5	41.2	

For mean roof heights over 60 ft, engineering calculations must be submitted for permitting.

Notes for Table 6MF:

- For attachment systems not listed in the table for 19/32" sheathing use the allowable aerodynamic uplift resistance from the table for 15/32" sheathing.
- Fasteners shall have a minimum edge distance of 1½ inches from the head of the tile and located in the pan of the tile to obtain the values in Table 6 MF. Consult the tile manufacturer for additional limitations or restrictions.
- Ring shank nails shall be 10d ring shank corrosion resistant steel nails with the following minimum dimensions: (3 inches long, 0.283 inch flat head diameter, 0.120 inch undeformed shank diameter or 0.131 inch screw diameter).
- Smooth or screw shank nails shall be 10d corrosion resistant steel (with the following minimum dimension. 3 inch long, 0.283 inch flat head diameter, 0.120 inch undeformed shank diameter or 0.131 inch screw diameter).
- Screws are #8 course threaded, 2.5 inches long corrosion-resistant steel wood screws conforming to ANSI/ASME B 18.6.1.
- The fastener hole nearest the overlock shall be used when a single nail or screw is required. The fastener hole nearest the underlock and the fastener hole nearest the overlock shall be used when two nails or screws are required.
- When using eave and field clips, attachment of the tiles is accomplished by a combination of nails and clips. Tiles are nailed to the sheathing or through the battens to the sheathing with one or two 10d corrosion resistant nails (Note 2 and 3 above) as required by Tables 5 and 6. Additionally, each tile is secured with a 0.060 inch thick and 0.5 inch wide clip which is secured to the plywood sheathing or eave fascia, as appropriate, with a single nail per clip. The nail shall be placed in the hole closest to the tile for clips having more than one nail hole. The following clip/nail combinations are permitted:
 - Aluminum alloy clip with 1.25 inch HD galvanized roofing nail (0.128 inch shank diameter).
 - Galvanized steel deck clip with 1.25 inch HD galvanized roofing nail (0.128 inch shank diameter).
 - Stainless steel clip with 1.25 inch HD galvanized roofing nail (0.128 inch shank diameter).
- Field clips and eave clips are to be located along the tile where the clip's preformed height and the tile's height above the underlayment are identical.
- Counter batten values not included.
- For attachment systems not listed in table for 15/32" sheathing, use allowable aerodynamic uplift moment from table for 15/32" sheathing.
- The allowable aerodynamic uplift moments include a generic restoring gravity moment of 6.5 ft-lbf for a direct deck installation and a generic restoring gravity moment of 5.5 ft-lbf for a batten installation

Drawing shown depicts the application of all tile profiles. Unless otherwise noted, it would apply to either concrete or clay tiles.

APPENDIX C

Glossary Of Terms

Abutment: The intersection between the roof and the chimney, wall or other vertical face.

Adhesives: A bonding agent to join two surfaces for the purpose of permanent attachment as approved by the local building official.

Anti-Ponding: A device such as beveled cant strip or shop formed sheet metal is recommended at all raised fascia conditions to support the underlayment.

Batten: A nonstructural horizontal fastening strip to which the roof tiles are attached.

Batten Lugs: Protrusions (anchor lugs) on the underside of the tile designed to engage over the upper edge of tiling battens.

Bedding: Refers to the installation of roof tiles to a mortar or adhesive foam patty and is structural in nature for the basic securement.

Bird Stop: A product used at the eave of a profile tile roof to stop birds from entering below the tile.

Booster Tile: Normally 3"-4" long tile strip used to lift up the cover tile. Sometimes it is used in boosting up field tile to create an authentic looking roof.

Cant Angle: The angle formed between the upper surface of the installed roof tile and the roof deck.

Clay Rooftile: An interlocking or non-interlocking clay roof covering, used to cover the roof surface.

Concrete Rooftile: An interlocking, or non-interlocking concrete roof covering, used to cover the roof surface.

Counter Battens: Vertical furring strips running beneath and perpendicular to horizontal tile batten, to allow drainage and air flow beneath the roof tile. Also known as strapping.

Counter Flashing: A flashing material that provides the enclosure at the transition line between the roof to wall flashing at intersecting vertical surfaces.

Counter Batten System: A method of elevating horizontal battens above the roof deck to allow drainage and air flow beneath the horizontal battens and roof tile.

Cricket: See *Saddle*.

Dead Loads: The weight of all materials of construction incorporated into the roof assembly including but not limited to, fixed service equipment, roof tiles, battens, underlayment, flashing, roof deck, etc.

Direct Deck: Those tiles fastened directly to the roof deck without the use of battens.

Eave: Outer edge of the roof downslope.

Eave Closure: A material available for S-tile or Pan and Cover tile. Eave closures are used to close the convex opening created by the shape of the tile at the eave. This accessory also provides the proper rise for the first course of tile. See Bird Stop.

Eave Riser: Method/material used for elevating the nose of the first course of tile to the plane of the field tile.

Fascia: A decorative board concealing the lower ends of the rafters or the outer edge of the gable.

Flashing: Impervious material used to cover, waterproof, and direct water away from roof penetrations and from intersections between the roof tile and other materials.

Fully Engaged: The horizontal batten material thickness shall be equal to or greater than the design depth of the anchor lug of the tile.

Gable End: The generally triangular area at the end of a sloped roof extending from the eaves to the ridge.

Head Lap: The measurement of the overlap between a course of roofing components and the course above.

Headwall Flashing: The flashing that is installed at the horizontal, intersecting wall or other vertical surface.

Hem: An edge of metal bent back on its self to give strength to the edge of the metal.

High Profile Tile: Those tiles having a rise to width ratio greater than 1:5. (Typically referred to as "S" or barrel, 2-piece, Pan & Cover tile). Measured in the installed condition.

Glossary Of Terms (Continued)

Hip: The exterior sloping ridge formed by the intersection of two inclined roof surfaces.

Hip/Ridge Tile: Accessory trim tile used to cover a hip or a ridge.

Hip Starter: The closed hip piece which is used at the outside corner, intersecting of two eaves to start the hip tile.

Interlocking Tile: Those tiles with a system of rib(s) or groove(s) enabling the joining of adjacent tiles in the same horizontal or vertical row, with the overlapping lock covering the underlapping lock.

Length: The maximum overall dimension of the tiles as measured parallel to the water course.

Live Loads: A load produced by the use and occupancy of the building or other structure that does not include construction or environmental loads, such as wind load, snow load, rain load, earthquake load, flood load, or dead load.

Low (Flat) Profile Tile: Low profile tiles are defined as those flat tiles having a top surface rise equal to or less than $\frac{1}{2}$ ".

Medium Profile Tile: Tiles having a rise greater than $\frac{1}{2}$ " and a rise to width ratio of less than or equal to 1:5.

Metal Drip Edge: Perimeter metal flashing installed to protect raw edges of roof deck.

Mortar: A mixture of cementitious material, aggregate, and water used for bedding, jointing, and bonding of masonry or roof tile and accessories.

Nail Hole: A small opening passing partially or totally through the tiles to allow the penetration of a nail, screw or other approved fastener for the purpose of fastening the tile to a support.

Nailer Board/Stringer: A piece of wood or other material of proper height, attached to a roof at the ridge and/or hips to allow for proper support and means of attachment for the hip and ridge tile. Can also be used in pan and cover applications under the cover tile for proper support. (Commonly known as a vertical stringer)

Non-Interlocking Tile: Those tile that do not have vertical rib(s) or grooves creating an interlocking tile.

Nose Clips: A fastening device designed to hold the nose (or butt) end of the tile against uplift or sliding down the slope. Also known as wind clips or tile locks.

Nose Lugs: Protrusion(s) on the underside of the tile that are designed to restrict the flow of weather between two consecutive courses of tile.

Organic Growth: In certain climatic regions of the country, the development of organic growths can occur on a building material. The growth can form on the dirt and moisture that accumulate on the surface of the tile.

Pan and Cover Tile: Semi-circular shape tile. Also known as two piece mission or barrel mission tile. There are tapered and straight two piece mission styles available.

Pan Flashing: Metal flashing running under the tile at the side walls.

Point-up: The application of mortar to fill voids to various ends, sides and angles of a tile roof, which are non structural in nature.

Profile: The contour of the top surface of the tiles when viewed from the nose end.

Rake Trim: A roof tiling accessory used to cover the intersection between the gable end and a roof.

Ridge Trim: The piece of ridge available to close off the gable end and peak of a roof. Some ridge tile have an interlocking feature and require either a "starter" or "finisher".

Ridge Tile: See hip/ridge tile.

Roof Live Load: A load on the roof produced (1) during the maintenance by workers, equipment, and materials and (2) during the life of the structure by movable objects, such as planters or other similar small decorative appurtenances that are not occupancy related.

Saddle Flashing: The flashing at the upper intersection between a chimney or skylight and the roof. (Commonly referred to as a Cricket or Back-pan)

Glossary Of Terms (Continued)

Side Clips: A fastening device for tile with a side interlock designed to prevent rotation of the tile when subjected to uplifting forces. Also known as hurricane clip.

Side Lap: The measurement of the overlap between a roofing component and a component to one side of it.

Side Wall: The vertical intersection that runs parallel to the roof slope.

Spaced Sheathing: Sheathing boards or battens, which are mechanically attached to the rafters or framing members, with gaps or spaces between them and is used in lieu of a solid sheathing.

Standard Weight Rooftile: Roof tile of mass/unit area of 9 lbs/ft² or greater installed weight excluding all other roofing components.

Starter Tile: First course of cover tile for two piece mission. Normally 3"-4" shorter than the field tile.

Step Flashing: A piece of flashing material covering each course of tile at sidewalls.

Stringer: See nailer board.

Sweat Sheet/Bleeder Sheet: A layer of underlayment under the valley metal to prevent moisture/condensation from entering the roof deck.

Tile Course: The horizontal increment of exposure.

Tile Thickness: Any vertical measurement of the cross section of the tiles excluding the lapping area, head or nose lugs, and weather checks.

Tile Thickness (visual): The overall thickness of the tile profile when installed as measured from the top surface of the lower tile to the top surface of the upper tile.

Tile Batten: See Batten

Underlayment: A water shedding membrane installed over the roof sheathing, rafters, or trusses. The underlayment may be rigid or roll form.

Valley: The angle of a roof where two slopes intersect internally.

Closed Valley: Where tile(s) are cut to meet at the center of the valley metal.

Open Valley: Where tile(s) are cut to expose the trough area of the metal.

Vent Tile: A tile designed to allow air circulation from the roof space to the outside.

Water Course: The valley portions of profiled tiles along which water drains.

Weather Blocking: A barrier of moldable or preformed rigid material which blocks the entry of wind driven moisture at openings between the field tile and trim tile or the field tile and roof flashing.

Weather Checks: Protrusion(s) on the tile that are designed to restrict the flow of water between two consecutive courses of tile.

Width: The maximum overall dimension of the tiles as measured perpendicular to the length of the water channel.

Width, Exposed: The maximum overall dimension of the tile as measured perpendicular to the length of the water channel minus the side lap of the adjacent roof tile.

Wire Tie System: A roof tile fastening system approved by the local building code, that limits the penetration of the underlayment and allows tile to be fastened to nonnailable roof decks.

TABLE 6
ROOF SLOPE CONVERSION

Slope/Pitch	Slope %	Ratio	Angle (deg.)
4:12	33	1:3	18.4
5:12	42	1:2.4	22.6
6:12	50	1:2	26.6
7:12	58	1:1.7	30.3
8:12	67	1:1.5	33.7
9:12	75	1:1.13	36.9
10:12	83	1:1.2	39.8
12:12	100	1:1	45.0
14:12	117	1.2:1	50.2
15:12	125	1:25:1	51.3
16:12	133	1.3:1	52.4
18:12	150	1.5:1	56.3
20:12	167	1.7:1	59.5
24:12	200	2:1	63.4
28:12	233	2.3:1	66.5
32:12	267	2.7:1	69.7
36:12	300	3:1	71.6
40:12	333	3.3:1	73.1
44:12	367	3.7:1	74.9
48:12	400	4:1	76.0

TABLE 7
METRIC CONVERSION

US	METRIC	US	METRIC
1 inch	25.4 mm	0° Fahrenheit	1.8 x °C + 32
1 foot	304.8 mm	1 pound (mass)/sq. ft.	4.88 kg/m ²
1 sq. inch	645.2 mm ²	1 yd ³	0.765 m ³
1 sq. foot	0.0929 m ²	1 inch of water	248.8 Pa
1 pound (mass)	0.453 kg	1 inch of mercury	3377 Pa
1 pound/ft	14.594 N/m	1 mph	1.61 km/h
1 pound/sq. in.	6894 Pascals (1 pa-N/m ²)	1 gallon	3.785 liters
1 pound/sq. ft.	47.88 Pascals	1 square (100 sq. ft.)	9.28 m ²

Drawing shown depicts the application of all tile profiles. Unless otherwise noted, it would apply to either concrete or clay tiles.

*Energy
Efficient*



Solid Investment



Strong



Tile Roofing Industry Alliance

2150 N 107th Street, Suite 330
Seattle, Washington 98133

p 206 209 5300

info@tileroofing.org

©2024 v.03.01

Installation Manual Courtesy Of Eagle Roofing Products



**Offer Your Customers Quality,
Durability and Longevity.**

As a roofing professional, it is imperative to build trust from the start and that begins by offering your customers the best, superior protection that will safeguard their property and their valuables for decades to come. A concrete tile roof from Eagle Roofing Products does just that by giving your clients a **beautiful, timeless roofscape** that will endure and provide **peace of mind**.

**Trust Eagle. America's top
concrete roof tile manufacturer.**

For more information contact your local
Eagle Account Representative by visiting:
eagleroofting.com/sales-teams

connect with us!



eagleroofting.com



Tile Roofing Industry Alliance

2150 N 107th Street, Suite 330
Seattle, Washington 98133

p 206 209 5300

info@tileroofing.org

©2024 v.03.01